



SONICS

Sonics & Materials, Inc.



*Model GXT*  
*Power Supply*

I N S T R U C T I O N M A N U A L

哥威雅（香港）有限公司

Qoovia Corporation (Hong Kong) Limited

Hong Kong Office: 15B Granville House, 41C Granville Road, T.S.T., Kowloon, Hong Kong

Tel: +86(00852)61717217 & 81463719 Fax: +86(00852)81479859

Dongguan Office: 6 Hang, No 17, Heng Xin Road Heng Gang Tou, Xin An Qu Chang An, Dongguan Guangdong, China 523882

Tel: +86(0769)8532-0321 Fax: +86(0769)8532-0145

[info@qoovia-hk.com](mailto:info@qoovia-hk.com) ♦ [www.qoovia-hk.com](http://www.qoovia-hk.com)

# WARNING



## **SAFETY PRECAUTIONS READ BEFORE INSTALLING OR USING THE EQUIPMENT**

This system has been designed to assure maximum operator safety. However, no design can completely protect against improper usage. For maximum safety and equipment protection, observe the following warnings at all times and read the instruction manual carefully before you attempt to operate the equipment.

- High voltage is present in the equipment. Disconnect plug before removing cover or servicing.
- Make sure equipment is properly grounded with a 3-prong plug. Before plugging in equipment, test outlet for proper earth grounding.
- Ultrasonic welders operate above normal audibility for most people. Ear protection is recommended.



哥威雅（香港）有限公司  
Qoovia Corporation (Hong Kong) Limited

Hong Kong Office: 15B Granville House, 41C Granville Road, T.S.T., Kowloon, Hong Kong  
Tel: +86(00852)61717217 & 81463719 Fax: +86(00852)81479859  
Dongguan Office: 6 Hang, No 17, Heng Xin Road Heng Gang Tou, Xin An Qu Chang An,  
Dongguan Guangdong, China 523882  
Tel: +86(0769)8532-0321 Fax: +86(0769)8532-0145

Information contained in this manual is subject to change without notice. Sonics & Materials, Inc. is not responsible for any typographic errors.

© Sonics & Materials, Inc. 2010

Printed in U.S

Rev 01, 9/10



[Go To Top Of Document](#)

INSTRUCTION MANUAL • MODEL GXT POWER SUPPLY  
[info@qoovia-hk.com](mailto:info@qoovia-hk.com) ♦ [www.qoovia-hk.com](http://www.qoovia-hk.com)

1

# TABLE OF CONTENTS

<b>IMPORTANT SERVICE LITERATURE</b> .....	4
Manual Change Information .....	4
<b>UNPACKING AND INSPECTION</b> .....	5
Visible Loss or Damage .....	5
Concealed Loss or Damage .....	5
<b>INTRODUCTION</b> .....	6
<b>OVERVIEW OF ULTRASONIC PLASTICS ASSEMBLY</b> .....	6
What is Ultrasonics? .....	6
Principal of Ultrasonic Assembly .....	6
Ultrasonic Assembly Systems .....	6
<b>GLOSSARY OF ULTRASONIC TERMS</b> .....	8
<b>INSTALLATION</b> .....	9
Electrical Power Requirements .....	9
Setting Up .....	9
Electrical Connections .....	10
Cable Connections – For Models with 700 to 2200 Watts Power ..	11
Cable Connections – For Models with 3000 or 4000 Watts Power ..	12
Available Converters .....	13
<b>OPERATING PROCEDURES</b> .....	14
Front Panel Controls and Indicators .....	14
Keying in Parameters .....	16
Operational Features .....	17
Starting up the Power Supply .....	17
Initial Operation .....	18
Ready Screens .....	18
Time Settings .....	20
Amplitude/Pressure .....	21
Trigger .....	21
<b>ADDITIONAL FEATURES AND FUNCTIONS</b> .....	22
Job Storage .....	22
Frequency Display .....	23
Overload Protection .....	23
<b>KEYPAD SECURITY</b> .....	24
<b>PRINT LINE OUTPUT</b> .....	25
<b>AUTOMATION INTERFACE &amp; I/O CONTROLS</b> .....	27
External Job Address Lines .....	29

<b>MAINTENANCE</b> .....	30
General .....	30
Repairs / Service .....	30
<b>WARRANTY</b> .....	31
Limitation of Warranty .....	31
<b>APPENDIX</b> .....	32
Print Line Output Data Items .....	32
Automation Interface & I/O Controls .....	35
Source/Sink Inputs and Outputs .....	35
Source/Sink Digital I/O Configuration .....	36
Sinking Output to PLC Input Diagram .....	37
PLC Output to Sinking Input Diagram .....	37
PLC Output to Sourcing Input Diagram .....	37
Two Isolated Loop Supplies .....	38
I/O Timing Diagram – Automated Controls .....	38
PLC Sample Code .....	39
Drawings .....	41
G-Series Switches .....	49

# IMPORTANT SERVICE LITERATURE



**NOTE:** Please read carefully before operating the equipment, then forward to your service department.

The system supplied with this instruction manual is constructed of the finest material and the workmanship meets the highest manufacturing standards. It has been thoroughly tested and inspected before leaving the factory and when used in accordance with the procedures outlined in this manual, will provide you with many years of safe and dependable service.

## MANUAL CHANGE INFORMATION

We continually strive to be at the forefront of the latest electronic developments by adding circuit and component improvements to our equipment as soon as they are developed and tested.

Sometimes, due to printing and shipping requirements, we cannot incorporate these changes immediately into printed manuals. Hence, your manual may contain new change information. Change information, if any, is located in the Appendix.

We reserve the right to make any changes in the design or construction of our equipment at any time, without incurring any obligation to make any change whatsoever in units previously delivered.

The technical data and schematics in the manual are for informational purposes only and may not reflect the current configuration being shipped from our factory. Upon formal request, complete and up-to-date information can be provided from the factory free of charge.



**SONICS**

[Go To Top Of Document](#)

# UNPACKING AND INSPECTION



**NOTE:** We recommend keeping all carton(s) and packing material in case it might be necessary to move the equipment, or to ship it for repair.

Before unpacking the equipment, check the shipping carton for any visible damage. If you see any, be sure to follow the procedures described below under “Visible Loss or Damage.” Otherwise, proceed to remove the equipment from the carton. Before storing any packing material, check it carefully for small parts. Then perform a visual inspection of the equipment to detect any evidence of damage which might have occurred during shipment. Check the following:

1. all components against the enclosed packing list,
2. all module plug-in units,
3. all wire plug-in connections.

The equipment was carefully packed and thoroughly inspected before leaving our factory. All units are tested and checked for problems prior to shipping. It is asked that when a problem does occur that all parts and components be inspected for damage (especially when the unit is not in working order when received). Responsibility for safe delivery was assumed by the carrier upon acceptance of the shipment. Claims for loss of damage sustained in transit must therefore be made upon the carrier, as follows:

## **VISIBLE LOSS OR DAMAGE**

Any external evidence of loss or damage must be noted on the freight bill or express receipt, and signed by the carrier’s agent. Failure to adequately describe such external evidence of loss or damage may result in the carrier’s refusal to honor a damage claim. The form required to file such a claim will be supplied by the carrier.

## **CONCEALED LOSS OR DAMAGE**

Concealed loss or damage means loss or damage which does not become apparent until the merchandise has been unpacked. The contents might have been damaged in transit due to rough handling even though the container may not show external damage. When the damage is discovered upon unpacking, make a written request for inspection by the carrier’s agent within 48 hours of the delivery date. Then file a claim with the carrier since such damage is the carrier’s responsibility. The form required to file such a claim will be supplied by the carrier. Do not destroy packing materials, or move material from one location to another before the carrier makes their inspection.

If the system or any unit is damaged, notify Sonics. Sonics will arrange for repair or replacement of damaged equipment without waiting for the claim against the carrier to be settled, provided a new purchase order is issued to cover the repair or replacement costs. Should any damage, shortage or discrepancy exist, please notify us immediately.

---

# INTRODUCTION

---

The GXT power supply is an ultrasonic generator with automatic frequency tuning and a built-in Microprocessor that features time controls. The Microprocessor is programmed with a multi-function keypad and information is displayed on the back-lit liquid crystal display (LCD). This power supply can be used with a pneumatic press or actuator, or with a stand-alone converter.

## OVERVIEW OF ULTRASONIC PLASTICS ASSEMBLY

---

### **WHAT IS ULTRASONICS?**

Ultrasonics refers to vibrational waves with a frequency above the human audible range which is usually above 18,000 cycles per second (Hz).

### **PRINCIPLE OF ULTRASONIC ASSEMBLY**

The basic principle of ultrasonic assembly involves conversion of high frequency electrical energy to high frequency mechanical energy in the form of reciprocating vertical motion which, when applied to a thermoplastic, generates frictional heat at the plastic/plastic or plastic/metal interface. In ultrasonic welding, this frictional heat melts the plastic, allowing the two surfaces to fuse together; in ultrasonic staking or insertion, the controlled flow of molten plastic is used to capture or lock another material in place (staking) or encapsulate a metal insert (insertion).

### **ULTRASONIC ASSEMBLY SYSTEMS**

Sonics ultrasonic assembly systems are generally composed of the following major elements: a power supply, converter, booster, horn, pneumatic press and holding fixture, as detailed in the diagram on the next page. A review of this diagram will help you understand the basic elements involved in the assembly process and their relation to each other.



**SONICS ULTRASONIC ASSEMBLY SYSTEMS**

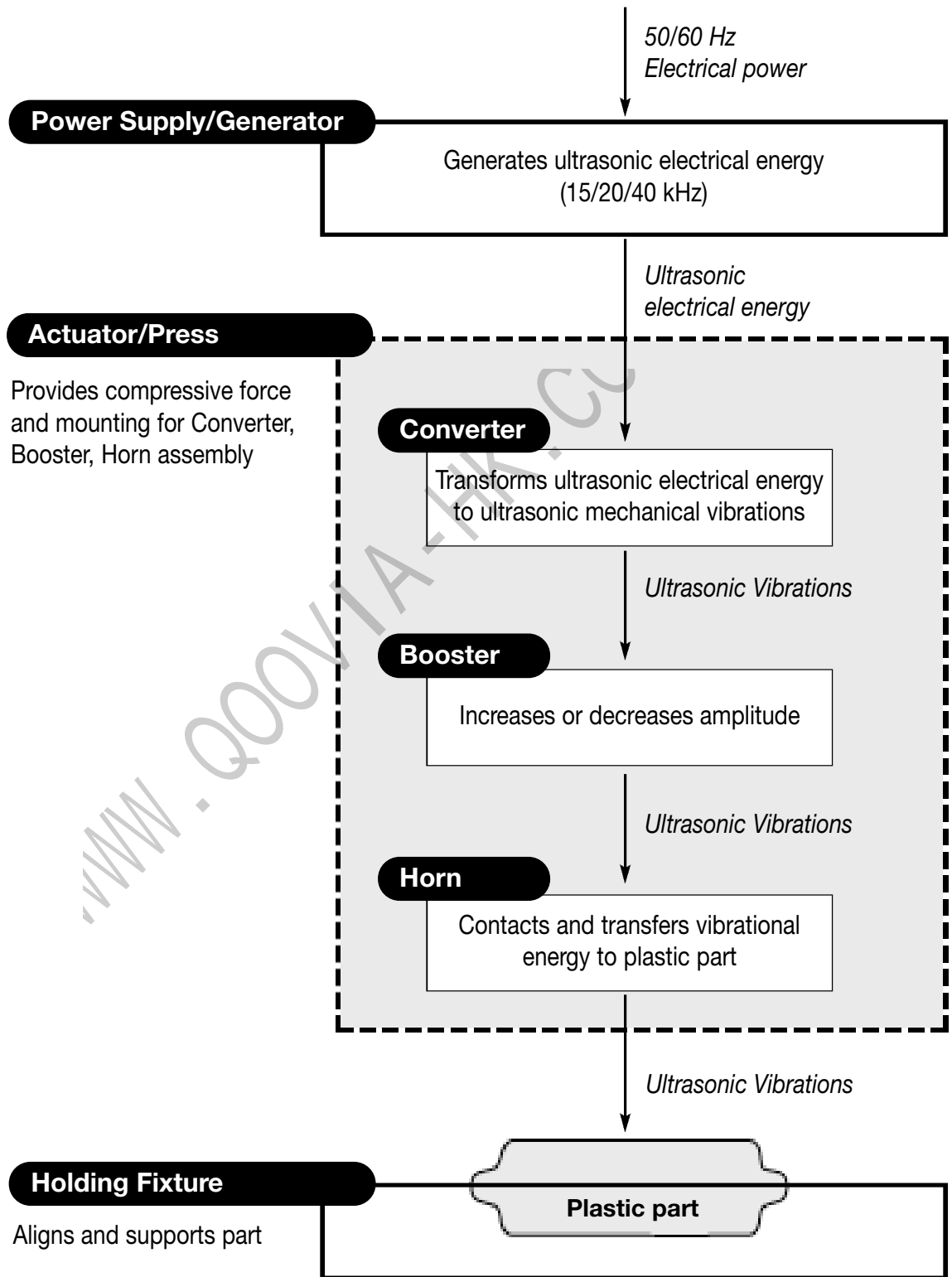



# GLOSSARY OF ULTRASONIC TERMS

---

**POWER SUPPLY/GENERATOR** – The solid state power supply converts standard 50/60 Hz electrical energy to 15,000 Hz, 20,000 Hz or 40,000 Hz (15/20/40 kHz) electrical energy.

**ACTUATOR/WELDING PRESS** – The pneumatic actuator provides compressive force and mounting for the converter, booster and horn assembly. The tabletop press consists of a base assembly, column and actuator (head).

**CONVERTER** – The converter changes the high frequency electrical energy supplied by the power supply to high frequency mechanical vibrations.

**BOOSTER** – Successful ultrasonic welding often depends on having the right amplitude at the horn face. Often it is not possible to design a horn which has both the necessary shape and required gain (ratios of input amplitude to output amplitude). In such cases, a booster is placed between the converter and the horn to either increase or decrease the amplitude of the horn. In addition to changing/maintaining the amplitude, the booster provides support and alignment in the welding system.

**HORN** – The horn is a tuned component of the system which comes in contact with the parts to be assembled. The horn 1) transfers the ultrasonic vibrations produced from the converter to the parts being welded, and 2) applies necessary force to the assembly while the material resolidifies.

**HOLDING FIXTURE** – The holding fixture or nest assures proper alignment and support of the parts being assembled.

# INSTALLATION



## WARNING

The line cord of the controller/power supply is equipped with a 3-prong, grounding plug. Do not, under any circumstances, remove the ground prong. The plug must be plugged into a mating 3-prong, grounding type outlet.

## ELECTRICAL POWER REQUIREMENTS

The power supply requires a fused, single-phase, standard 3-terminal grounding type receptacle capable of supplying the requisite voltage and current. Refer to the table below for power specification.

### POWER SPECIFICATIONS

Model	Power Rating/ Frequency	Fuse rating	
		115 vac	230 vac
GXT400-40	400w - 40 kHz	15 amps	10 amps
GXT800-40	800w - 40 kHz	15 amps	10 amps
GXT1200-20	1200w - 20 kHz	15 amps	10 amps
GXT1700-20	1700w - 20 kHz	N/A	20 amps
GXT2200-20	2200w - 20 kHz	N/A	20 ampT
GXT3500-20	3500w - 20 kHz	N/A	30 ampT
GXT2200-15	2200w - 15 kHz	N/A	20 amps
GXT3500-15	3500w - 15 kHz	N/A	30 amps
GXT4500-15	4500w - 15 kHz	N/A	30 amps



**NOTE:** If power supply is to be run continuously, air cooling of the converter and horn is required. Use clean, dry compressed air filtered down to 5 microns (supplied to converter fitting – see page 12).

## SETTING UP

The power supply is a free-standing assembly. It should be installed in a clear, uncluttered location that is free from excessive dirt, dust, corrosive fumes, and temperature and humidity extremes. The selected installation site should be near the electrical power source and away from equipment that generates abnormally high electrical transients. Observe the following additional instructions when installing the equipment:

- Allow at least 6 inches (152.4mm) at the rear of the power supply for cable connections.
- Position the power supply so that the front panel controls are visible and readily accessible.
- The power supply is air cooled; allow sufficient space around the assembly to ensure adequate ventilation. If the power supply must be housed in a confined space, forced air cooling may be necessary to keep surrounding air within acceptable ambient temperature limits. Periodically check the ventilation grille and clean as necessary.





**NOTE:** Do not plug the power supply into an electrical outlet until all other connections have been made.

## **ELECTRICAL CONNECTIONS**

The standard cable supplied with a Sonics press is 10 feet. Optional extension cables are available up to 15 feet without modification.

When making the initial electrical connections, make sure the power is disconnected and follow these precautions.

1. Do not strain or kink the cables. When going around corners, allow as wide a bend as possible. Do not run the cables parallel to any power line within a distance of less than 1 foot (305 mm).
2. To prevent the possibility of an electrical shock, ensure that the power supply line cord is properly grounded. Also make sure that the voltage rating of the electrical power source matches the power supply requirement (refer to the “Power Specifications” table on preceding page).
3. Check with your electrician if you have any wiring questions.

WWW.QOOVIA-HK.COM





**NOTE:** Detailed wiring diagrams are supplied in the Appendix at the back of this manual.

### **CABLE CONNECTIONS – For Models with 700 to 2200 Watts Power:**

Located at the rear of the power supply are the cable connections as illustrated below. (The interconnecting cables will be supplied with your system.)

- ❶ J1, a round, 12-pin RF cable that connects the welding press or converter to the power supply.
- ❷ J2, an actuation cable that connects the power supply to a trigger source (press cable or external trigger source.) Refer to wiring diagrams in Appendix.
- ❸ The power line cord that plugs into the appropriate electrical outlet.

Once these connections have been made, the power supply is ready for operation. If applicable, be sure to consult your welding press instruction manual to insure that all connections on the press side are correct, and

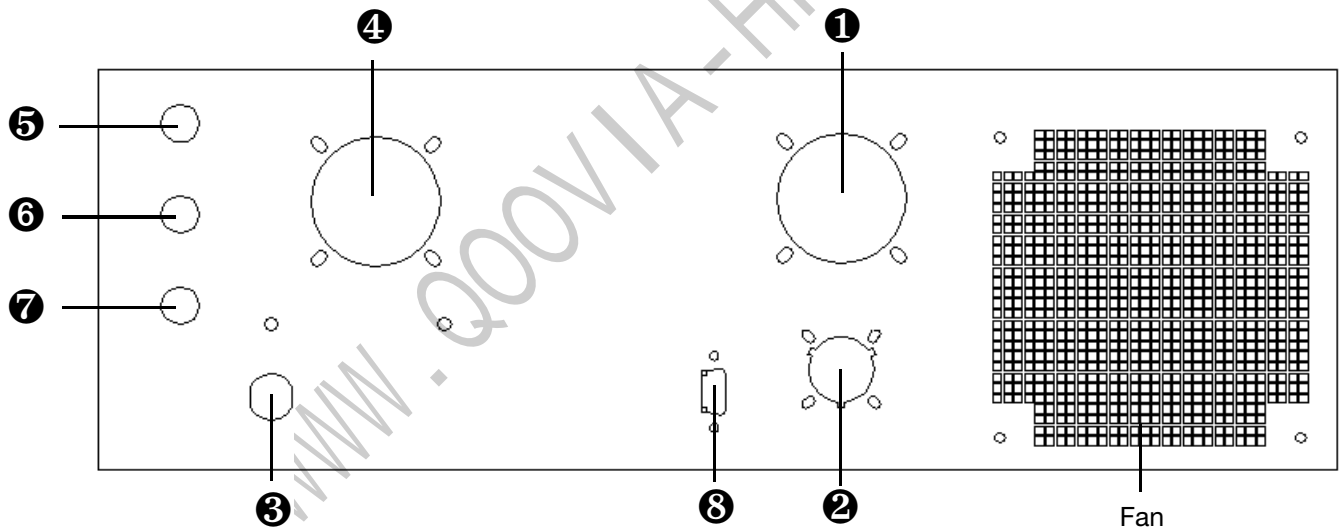

**NOTE:** To see a list of converters that can be connected to the power supply, see the table on the following page.

that the press is ready for operation.

Also located at the rear of the power supply are the following:

- ❹ J5 External I/O
- ❺ Fuse (0.5 amp - internal low voltage)
- ❻ Line fuse (based on requirements listed in “Power Specifications” table, page 9),
- ❼ Line fuse (based on requirements listed in “Power Specifications” table, page 9),
- ❽ J4 Serial Output



**NOTE:** Detailed wiring diagrams are supplied in the Appendix at the back of this manual.

### **CABLE CONNECTIONS – For Models with 3000 or 4000 Watts Power:**

Located at the rear of the power supply are the cable connections as illustrated below. (The interconnecting cables will be supplied with your system.)

- ❶ J1, a round, 12-pin RF cable that connects the welding press or converter to the power supply.
- ❷ J2, an actuation cable that connects the power supply to a trigger source (press cable or external trigger source.) Refer to wiring diagrams in Appendix.
- ❸ The power line cord that plugs into the appropriate electrical outlet.

Once these connections have been made, the power supply is ready for operation. If applicable, be sure to consult your welding press instruction manual to insure that all connections on the press side are correct, and that the press is ready for operation.

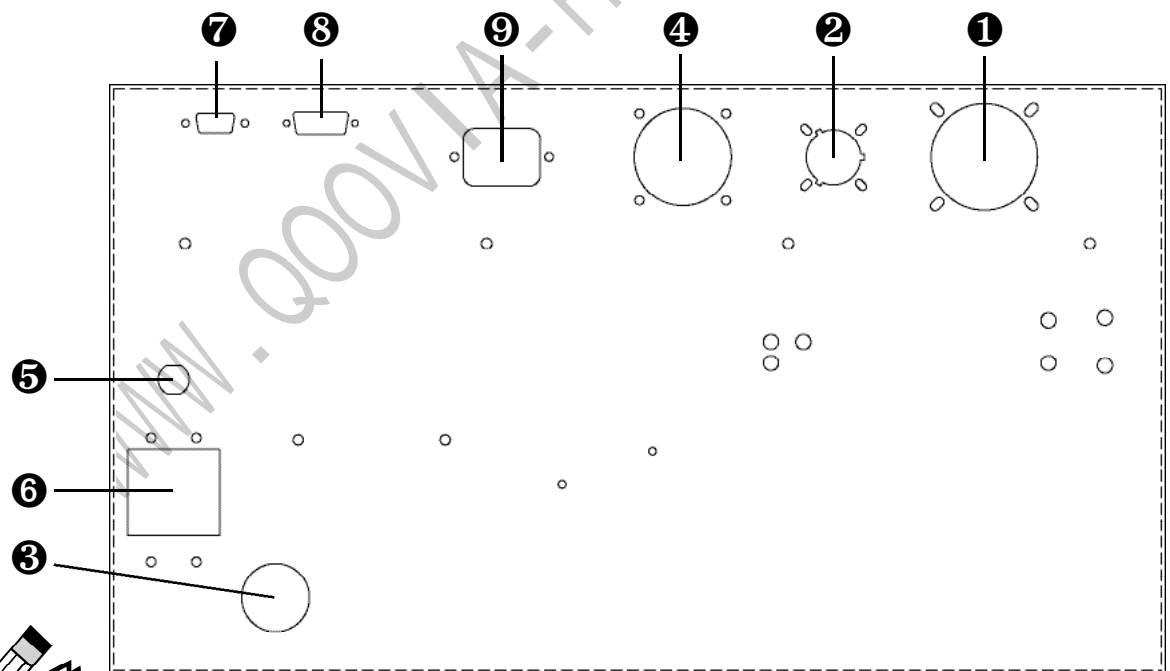

**NOTE:** To see a list of converters that can be connected to the power supply, see the table on the following page.

Also located at the rear of the power supply are the following:

- |   |  |
|---|--|
| ❹ J5 External I/O                       | ❷ J4 Serial Output                                 |
| ❺ Fuse (0.5 amp - internal low voltage) | ❸ J3 Linear Encoder                                |
| ❻ Circuit breaker                       | ❹ J6 on 15 kHz models only. Press motor connector. |

## AVAILABLE CONVERTERS FOR POWER SUPPLIES

Item No.	Description
CV00016	15 kHz with Button connector (O-ring mount)
CV00161	15 kHz with Lemo connector (O-ring mount)
CV00034	15 kHz with Button connector (O-ring mount) rated up to 4500 watts
CV00341	15 kHz with Lemo connector (O-ring mount) rated up to 4500 watts
CV00015	20 kHz with Button connector (O-ring mount)
CVR0015	20 kHz with Button connector (rigid mount)
CV00151	20 kHz with Lemo connector (O-ring mount)
CVR0151	20 kHz with Lemo connector (rigid mount)
CV00154	20 kHz with Lemo connector and fitting for air cooling (O-ring mount)
CVR0154	20 kHz with Lemo connector and fitting for air cooling (rigid mount)
CV00157	20 kHz with Button connector and fitting for air cooling (O-ring mount)
CVR0157	20 kHz with Button connector and fitting for air cooling (rigid mount)
CV00158	20 kHz Hand Gun with handles and cables (O-ring mount)
CVR0158	20 kHz Hand Gun with handles and cables (rigid mount)
CV00331	20 kHz with Fischer connector
CV00334	20 kHz with Fischer connector and fitting for air cooling
CVR0023	40 kHz with Button connector (rigid mount)
CVR0231	40 kHz with Lemo connector (rigid mount)
CVR0233	40 kHz with SHV connector side mounted (rigid mount)
CVR0234	40 kHz with Lemo connector and fitting for air cooling (rigid mount)

# OPERATING PROCEDURES

## FRONT PANEL CONTROLS AND INDICATORS

Located on the front panel of the power supply are the following controls and indicators:

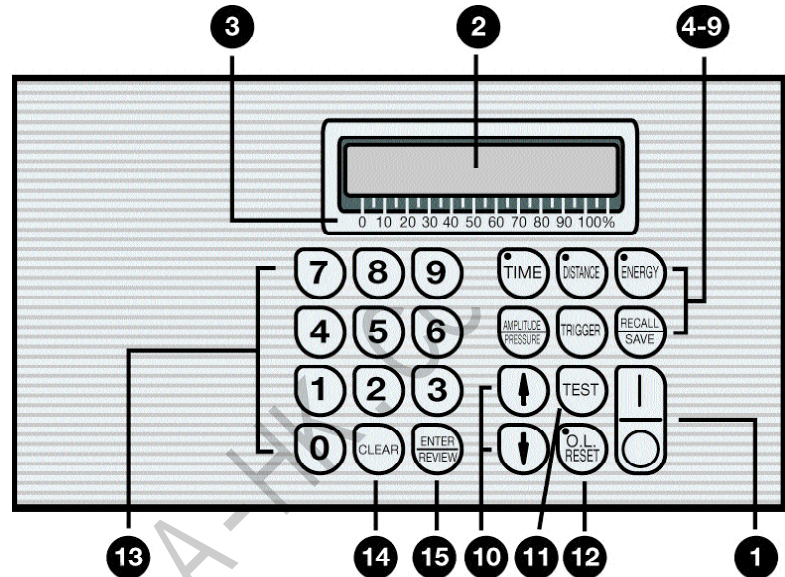

1. **ON/OFF** keys which turn the unit on and off.
2. **LCD SCREEN** which displays various settings, parameters and prompts as detailed in the following pages. In addition, during the weld process it displays a load meter indicator showing the power level of ultrasonics that is being delivered to the welding press (see #3 below).
3. **LOAD METER SCALE** from 0 to 100% which (in conjunction with vertical line indicators on LCD display) shows the running power (bar graph at bottom of display) and peak power (single vertical line at top of display) during the weld. Peak power is reported as %Pmax after the cycle (see page 16).
4. **TIME** key allows selection and display of time settings and permits adjustment of time duration in .01 second increments (from 00.00 to 99.99 seconds) for five time parameters as follows:
  - a. Weld time
  - b. Hold Time
  - c. Delay time
  - d. Afterburst Time
  - e. Time Limit Low
  - f. Time Limit High

*For a complete explanation of these parameters, refer to page 19.*

5. **DISTANCE** key. Option not available with Model GXT.
6. **ENERGY** key. Option not available with Model GXT.
7. **AMPLITUDE/PRESSURE** key which controls adjustment of the following amplitude and pressure settings of the system's high-frequency vibrations over the full operating range. (Major adjustments of amplitude can be made through the use of different boosters – consult your press manual for further information.)
  - a. Amplitude Setting
  - b. Amplitude Ramp (only on systems configured for more than 2200 watts)
  - c. Trigger Force (Press)
8. **TRIGGER** key which displays and permits selection of the trigger mode from the following options –
  - a. Delay Timer
  - b. Force/Pressure
  - c. Pretrigger - Top
9. **RECALL/SAVE** key which allows up to 15 different jobs to be stored (saved) and recalled or changed upon demand.
10. **ARROW** keys (Up/Down) which allow scrolling through some menus and also serve as a toggle for displayed parameter options in some menus.
11. **TEST** key which can be used to test ultrasonic operation and displays idle losses of converter/booster/horn as a percentage of maximum power when key is depressed. Also functions as a frequency display.
12. **O.L. RESET** key which resets the power supply following an overload condition. Red LED in upper left corner indicates an overload condition exists.
13. **0-9 NUMERIC KEY PAD** which allows input of numeric data or numeric selection options by pressing the keys.
14. **CLEAR** key which cancels a prior parameter value when a new value is to be entered.
15. **ENTER/REVIEW** key which Enters data into the system as keyed in with the numerical keys and displayed on the LCD screen. In Review function, displays the alarm, mode and cycle information.



## **KEYING IN PARAMETERS**

To make numeric entries into a cursor location that is displayed on a screen menu, use the numeric keypad. When the desired entry is displayed on the LCD screen, use the ENTER key to register the new value. Entries are made left to right.

The CLEAR key will clear an existing value to 0, displayed as a series of dashes, and relocate the cursor to the extreme left-hand entry position ready to accept entries again. As soon as a desired value is keyed in and displayed, pressing the ENTER key makes the system accept that entry. If a number value is not “Entered,” then it will not be accepted by the system and the parameter value will return to its former setting (before any numerical values were changed).

WWW.QOOVIA-HK.COM



## **OPERATIONAL FEATURES**

- Adjustable Afterburst Timer to separate parts from horn.
- Adjustable tolerance limits in time (sec) with visual alarms.
- Information displays including: number of assemblies, number of rejects, and number of cycles.
- Fault displays.
- Keypad security.
- Self-diagnostic input test.
- Storage capabilities of up to 15 jobs.
- RS-232 Printer monitor interface permits connection to a printer or computer.
- External job selection when the keyboard is “locked.”

## **STARTING UP THE POWER SUPPLY**

Press the ON/OFF key to turn the power supply on. The LCD screen will briefly display “Start Sequence” and show wattage and frequency information. Then the LCD screen will show the following “ready” display:

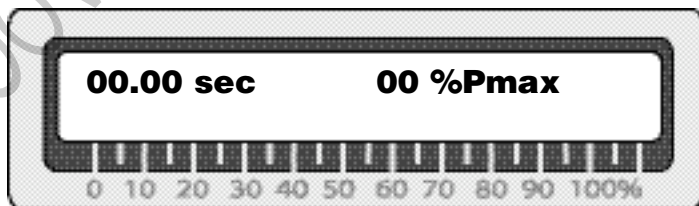

This display shows the last weld information for weld time and power. (After power down and subsequent power up, values are cleared to zero.)

## INITIAL OPERATION

After the power supply is turned on (as described on previous page), follow these steps:

1. Make sure that all necessary preparations have been made with regard to the ultrasonic system and tooling, and that the items to be welded are in position.
2. Press and hold the **TEST** button. While depressing the **TEST** button, check the LCD display. Make sure the bar graph indicator on the LCD display (a series of vertical lines that register to the 0 to 100% load meter scale – see example below) does not exceed 20%.



**NOTE:** The **TEST** and Load Meter check should always be done for all cold start-ups, and for any start-up after the system has been idle for 20 minutes or more.

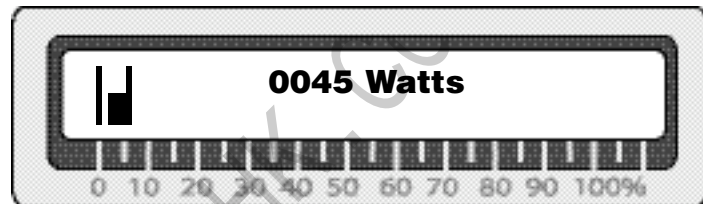

During the testing process, keep in mind that the ultrasonics are only activated as long as the TEST button is depressed – once you release the TEST button, ultrasonics is terminated.

A bar graph indicator reading of above 20%, signals that there may be a problem with the stack. Check your assembly and re-test.

3. The power supply is now ready for operation.

## Frequency Display

The TEST key can also be used to display the running ultrasonic frequency being used by the system. Refer to page 22 for more information.

## READY SCREENS

In addition to the start-up ready screen (shown on page 16), there are 2 other “ready” screens. The system must be displaying one of the 3 ready screens in order for welding to commence. Welding cannot be initiated from any other display. The other 2 ready screens are as follows:

### Alarm Screen

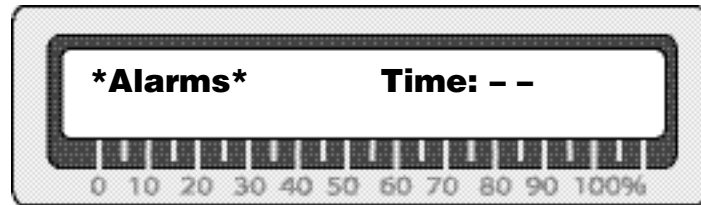

The Alarm screen displays information about the alarm(s) that have been triggered by the system encountering parameters outside of the specified tolerance limits. The screen will indicate an alarm that occurs in Time. If there are no alarms, dashes will display. If there are alarms, an L (for Low limit, indicating that the low limit was violated) and/or an H (for High limit, indicating that the high limit was violated) will display. When a new cycle begins, the system will automatically clear the current alarm.

### Counter Screen

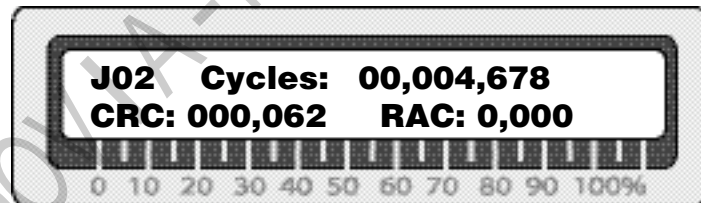

The Counter screen displays information about the job number, the number of cycles run to date, the customer resettable counter (CRC) and the resettable alarm counter (RAC). The 2 resettable counters can be reset whenever desired by pressing the Clear key when the counter screen is displayed (the keypad must be unlocked).



**NOTE:** If no time is set, an error message (“Set Weld Timer”) will display prompting a parameter entry.



**NOTE:** A review of the Basic Weld Cycle Time Line on page 47 gives additional information on how the weld cycle and settings operate.

## TIME SETTINGS

There are five time parameters, or timers, that can be set. They are accessed by pressing the Time key which allows specification of the following time parameters. The first menu display will show the following:

**Weld Time** – sets the duration of time for which ultrasonic vibrations are applied to the parts. A time value must be entered in order to weld.

Press the Time key again (and successively after each menu display) to advance to these next screen displays:

**Hold Time** – sets the duration of time for which pressure is maintained to ensure proper bonding of the parts, after the actual weld time and with ultrasonics off. (This allows the weld to cool.)

**Delay Time** – sets the duration of time allotted for pressure to build up after the parts have been contacted and before the application of ultrasonic vibrations to the horn. (“Delay Timer” must be selected as the trigger mode – see page 20 – and a value equal to or greater than 0 must be set.)

**Afterburst Time** – sets the duration of time for another application of ultrasonic vibrations to the horn (for “shake-off”) to ensure that the parts being assembled do not adhere to the horn.

**Time Limit Low** – sets the low time alarm examination point (as a tolerance limit). A time alarm will be triggered if the actual weld time is less than this value. The time low alarm will show on the Alarm Screen display and will be indicated by a flashing LED on the Time key. By specifying values for this limit and the Time Limit High, a weld time “window” is created that defines a “good weld.” (If no alarms are triggered – the weld cycle occurred within the designated time limits.)

**Time Limit High** – sets the high time alarm examination point. A time alarm will be triggered if the actual weld time is greater than this value. The time high alarm will show on the Alarm Screen display and will be indicated by a flashing LED on the Time key.





**NOTE:** Major adjustments of amplitude and pressure are made on the press through the use of boosters and pressure controls.

## **AMPLITUDE/PRESSURE**

Fine adjustments of the following amplitude and pressure settings can be made by using the Amplitude/Pressure key. All settings range from 20% (minimum) to 100% (maximum).

**Amplitude Ramp** – (only on systems configured for more than 2200 watts) Used primarily for 15 kHz systems to ensure a slow start-up when welding with big horns.

**Trigger Force (Press)** – this setting can be used to specify the pressure that needs to be reached to trigger the ultrasonics when “Force/Pressure” has been selected as the Trigger mode.

**Amplitude Setting** – this setting is used to specify the vibrational amplitude.

## **TRIGGER**

Selection of the trigger mode is achieved by pressing the Trigger Key and then using the Up/Down arrow keys as a toggle to select one of the following modes to act as the trigger to start ultrasonics.

**Delay Timer** – selecting this mode means that the ultrasonics will be triggered when the Delay Time specified in the Time menu is reached.

**Force/Pressure** – selecting this mode means that the ultrasonics will be triggered when the Trigger Force (Pressure) specified in the Amplitude/Pressure menu is achieved.

**Pretrigger - Top** – selecting this mode means that the ultrasonics will be triggered as soon as the head assembly leaves its home (head up) position and starts descent. This means that ultrasonics will be on before contact is made with the parts to be welded.

# ADDITIONAL FEATURES AND FUNCTIONS

## JOB STORAGE

Up to 15 different jobs may be stored and recalled or changed upon demand. Typical job parameters stored include Time and Power, Force Trigger, Limits, and Amplitude.

### Save

To use the job storage feature, press the Recall/Save key. If the “recall” option is displayed on the screen press the button again. The Save display appears as follow:



Saved jobs will be numbered 01 through 15. To save a job, use the numerical keys to enter in the desired job number (01 – 15). Once the job number is keyed in, press the ENTER key. All the parameters for that job will be saved under the job number keyed in. The system will return to the ready screen.

### Recall

To recall a job that has been saved, press the Recall/Save key. If the “save” option is displayed on the screen press the button again. The Recall display appears as follow:

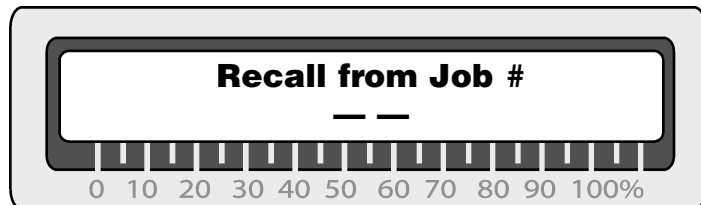

Recalled jobs are numbered 01 through 15. To recall a job, use the numerical keys to enter in the desired job number (01 – 15). Once the job number is keyed in, the settings for that job will be displayed on the various parameter menus.

The System will not respond if there is no job saved under a number corresponding to the numerical key pressed.

## **FREQUENCY DISPLAY**

The TEST key can also be used to display the running frequency. When the press head is in the UP position, press and hold the TEST key for 3 seconds. The information on the display will change from the power display (watts) to a frequency counter display (Hz). After this switch, the power is captured (no longer updated) and the frequency display will update every second. This information can help diagnose problems with the horn and/or stack assembly.

## **OVERLOAD PROTECTION**

The overload protection circuit will terminate ultrasonics when the system is operated under adverse conditions, i.e., improper tuning, excessive power supply loading, loose or failed horn or booster, thereby protecting the power supply and other system components. When an overload condition exists, a repetitive beep will sound and the **O. L. RESET** button will illuminate and remain lit until the button is pressed (regardless of whether the condition is corrected or not). If a repeated overload condition exists, resolve the problem before a failure of the power supply occurs.

If an overload condition exists, refer to the actuator instruction manual which may recommend one of the following possible solutions:

- decrease horn force
- decrease amplitude (change booster or decrease output control)
- decrease downspeed
- check for loose or broken studs
- check the coupling surfaces between horn/booster and booster/converter
- check for cracked horn or booster
- check to see if the load meter exceeds 100% during weld process (if so, a higher powered unit is needed)

If you cannot remedy the situation, contact Sonics' Service Department at 1-800-745-1105.



# KEYPAD SECURITY

---

The keypad can be “locked,” so that no new parameters or commands can be entered via the keyboard, thereby preventing unauthorized cancellation or adjustment.

To activate the security feature, press and hold the numeral 7 key on power up. When the keypad is secured in this manner, any attempt to change or enter parameters will result in the following message being displayed on the LCD screen:

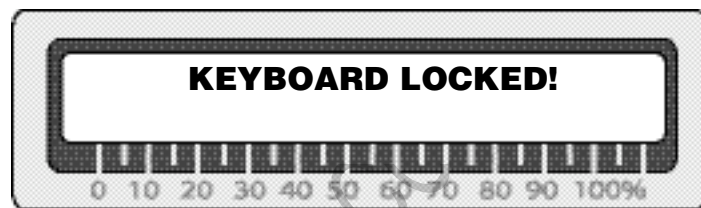

To return to normal operation and unlock the keypad, power down and repeat the lock procedure – press and hold the numerical key 7 on power up.

NOTE: for external job recall, the keyboard must be locked.

# PRINT LINE OUTPUT



**NOTE:** The Print Line option default is "OFF." Switch 5 determines OFF/ON (see page 48).



**NOTE:** Use of a printer causes the cycle to be extended by approximately 100 ms.

At the end of every weld cycle, the power supply sends an ASCII print line which includes the data for weld time, maximum power and alarm status. This line can be directed to a printer, a PLC ASCII card or a computer running any terminal program that will present the information. (The hyperterminal program is included with any PC under the Accessories/Communications directory. Note that the communication channel is not bi-directional at this time; it is an output print line only.)

The transmission settings are fixed at: 19200 bits per second, 8 data bits, parity = None, 1 stop bit and flow control = None. The cabling and connector arrangement is set to use a standard 9-pin Null Modem cable, the same RS232 cable that would be used to connect two PC computers together.

The order of the data is the same for each line and the length of the line does not change with the values of the data. Line length could be important if a receiving device is attempting to parse the data for other uses. It means that the data items are always in the same place and therefore much easier to remove from the print line.

The end of each print line contains two non-printable characters, a carriage return followed by a line feed character. These characters are standard RS232 control characters to position the cursor location to the beginning of the next line on the screen or print page.

### Sample Print line:

1	2	3	4	5	6	7	8
005647	00.48 sec	0.025 in	000130 J	045 %Pmax	Alarms T:-- D:-- E:--	J06	----
005648	00.47 sec	0.025 in	000130 J	045 %Pmax	Alarms T:-- D:-- E:--	J06	----
005649	00.45 sec	0.025 in	000130 J	045 %Pmax	Alarms T:-- D:-- E:--	J06	----
005650	00.48 sec	0.025 in	000130 J	045 %Pmax	Alarms T:-- D:-- E:--	J06	----
005651	00.47 sec	0.025 in	000130 J	045 %Pmax	Alarms T:-- D:-- E:--	J06	----
005652	00.45 sec	0.025 in	000130 J	045 %Pmax	Alarms T:-- D:-- E:--	J06	----
005653	00.48 sec	0.025 in	000130 J	045 %Pmax	Alarms T:-- D:-- E:--	J06	----
005654	00.47 sec	0.025 in	000130 J	045 %Pmax	Alarms T:-- D:-- E:--	J06	----
005655	00.45 sec	0.025 in	000130 J	045 %Pmax	Alarms T:-- D:-- E:--	J06	----
005656	00.49 sec	0.025 in	000130 J	045 %Pmax	Alarms T:-- D:-- E:--	J06	----
005657	00.46 sec	0.025 in	000130 J	045 %Pmax	Alarms T:-- D:-- E:--	J06	----
005658	00.46 sec	0.025 in	000130 J	045 %Pmax	Alarms T:-- D:-- E:--	J06	----
005659	00.47 sec	0.025 in	000130 J	045 %Pmax	Alarms T:-- D:-- E:--	J06	----

From left to right, the data items show the following information: (for more detailed information on these items and the print output, refer to the Appendix)

**Position 1** = Customer Resettable Counter (CRC)

**Position 2** = Actual weld time

**Position 3** = Distance data (applicable for Model GXL only)

**Position 4** = Energy data (applicable for Models GXL or GXE only)

**Position 5** = Maximum percent power number

**Position 6** = Any alarm violations for time

**Position 7** = The last job number saved or recalled from job storage memory

**Position 8** = Used to indicate a weld cycle termination due to an external cause

WWW.QOOVIA-HK.COM

# AUTOMATION INTERFACE & I/O CONTROLS

As listed below, there are several interface signals available for operating the power supply via external digital control lines. These lines are used to initiate a weld cycle and to monitor the operation (see External I/O Connection drawing E-3164 in the Appendix).

**1. Impulse Input** – the impulse input signal is used to initiate a weld cycle by external contact to ground. The contact must be closed for a minimum of 50 milliseconds for the welder to recognize the command. Once initiated, the weld cycle will proceed and the contact should be released. The contact must be released before the end of the weld cycle; the system will wait for the impulse contact to open before returning to the ready screens for data presentation. The impulse input is expecting a dry contact closure between J2 pin J and K (see Impulse Actuation Cable drawing E-2703 in the Appendix).

**2. Ready Output** – when the system is ready to run a cycle, the ready signal will be true. Any automation system should monitor this signal prior to initiating a weld cycle with the impulse input. The ready signal will be set false when a weld cycle begins. It will return true at the end of the weld after the data has been written to the selected ready screen, the print line has been sent (if ON) and the alarm signals have been examined and set.

In practice, automation controls should verify that the ultrasonic press is up and out of the way before loading the next “parts-to-be-welded” into the fixture and initiating another weld cycle. The ultrasonic system does not require the press to return “Home” before the next cycle can begin, so welding could possibly be initiated before the next parts-to-be-welded are in the ready position.

**3. Good Part / Bad Part Outputs** – There are two outputs that indicate the status of the last weld cycle. Both of these status signals are set false at the beginning of a weld cycle when the ready signal is set false (to indicate that a cycle is underway). One of these signals will be set true based on examination of the alarm settings at the end of the cycle. If any alarm examination points (process limits) have been violated, the Bad Part Output will be set true. If there are no alarm violations or no limits have been set, the Good Part signal will be set true.

The Good Part / Bad Part signals are meant to provide an external controller with the information necessary to handle the previously welded part in the automation environment. If the part is “good” then send it to the Good part location, if it’s “bad” then recycle or remove it for further examination.

The Good Part / Bad Part outputs will be valid prior to the ready signal returning to true at the end of a cycle. The system should use the ready

signal to qualify these outputs, if ready is true, then the Good Part / Bad Part outputs are valid.

**4. DO4** – There is one extra digital output that is reserved for future application.

**5. DI1, DI2, DI3 and DI4** – Four digital input signals are used for setting an external job selection when the keyboard is “Locked.” 15 sets of weld control parameters may be stored in the controller’s battery RAM area. (see page 21, Job Storage). They may be recalled into the working job area by setting a binary address code with these digital inputs (see table below). Valid jobs must exist and have been previously stored via the keyboard entries. All valid jobs must have a non-zero weld time entry. If a job does not contain a non-zero time entry, a weld cycle cannot be initiated.

The keyboard must be locked (see page 23) and the system must be at a Ready screen for the job address inputs to be active. The inputs are ignored if these conditions are not set. The keyboard must be locked so that job or data changes cannot be requested from two different sources – the keypad and remote address lines – at the same time. Only one source of job change is allowed: the keyboard (if not locked) or the digital inputs (when the keyboard is locked).

The job address lines may be changed anytime but must be held stable for a minimum of 50 ms prior to initiating a weld cycle with the impulse input command contact. When a job change has been recognized, the system will momentarily indicate Not Ready for a maximum of 30 ms while the job settings are recalled from battery backed RAM and the system internals are reset for a new cycle. The impulse command should be delayed until the Ready signal returns from the job recall operation if external job setting is used.

For the quickest possible cycle time, the next job address may be set after the present weld cycle begins as indicated by the ready signal (false). This does not affect the present weld cycle as it is already underway and the settings cannot be changed during the present cycle. They are locked once a cycle has started. If the job address has been changed during the present weld to reflect the desired job for the next weld cycle, the recall operation will happen at the end of the weld cycle before the final Ready indication.

Once Ready is true, the job has already been changed and the system is Ready to initiate the next cycle. This method extends the weld cycle by 30 ms which are needed to recall the job settings for the next cycle. Depending on weld times, up to 80 cycles per minute may be achieved including job changes between each weld (print line must be OFF to achieve this cycle rate).

## EXTERNAL JOB ADDRESS LINES

0= OFF or open line  
1= ON or contact closed

DI1	DI2	DI3	DI4	JOB#
0	0	0	0	No job change
1	0	0	0	1
0	1	0	0	2
1	1	0	0	3
0	0	1	0	4
1	0	1	0	5
0	1	1	0	6
1	1	1	0	7
0	0	0	1	8
1	0	0	1	9
0	1	0	1	10
1	1	0	1	11
0	0	1	1	12
1	0	1	1	13
0	1	1	1	14
1	1	1	1	15

Note that job Code 0 (0, 0, 0, 0) is not a valid job code and does not cause a job recall operation. Ex: If the last job recalled was Job 10 and the inputs are set to code 0, then Job 10 still dictates the active job settings.

The digital inputs (DI1, DI2, DI3, DI4) and the digital outputs (DO1, DO2, DO3, DO4) are set for "Sourcing" as shipped from the factory. They can be changed to "Sinking" by moving two optical isolator chips (U28/U44 for inputs; U43/U42 for outputs) on the internal microprocessor controller if desired. They are completely isolated and floating from the internal power levels and they are not required to be set the same. The inputs and outputs are set as a group so all 4 signals will be the same configuration. You may set one for "Source" and the other for "Sink" if required by the application interface. This can eliminate relay logic conversions to save parts and panel space for some PLC input/output cards. The chips are both optical isolator chips (PS2501-4 quad optical isolators; digikey part# PS2501-4-ND, as of this printing) available from most electronic distributors. The isolators are rated for 30 VDC, 100 ma max – do not connect AC voltage levels!

For more detailed information and to view applicable drawings, refer to Appendix.

# MAINTENANCE

---

## GENERAL

1. Always make sure the power supply has adequate ventilation by keeping sufficient space around the assembly.
2. Periodically check the ventilation grilles and clean as necessary.

## REPAIRS / SERVICE

If problems are encountered, contact our Service Department at 1-800-745-1105.

It is suggested that a system in need of repair be sent back to the factory with a written description pertaining to the nature of the problem.

**Always contact the factory for return authorization** before shipping any instrument. Include date of purchase, model number, and serial number. For units not covered by the warranty, a purchase order should be forwarded to avoid unnecessary delay. Care should be exercised to provide adequate packing to insure against possible damage in shipment. The system should be sent with all transportation charges prepaid and return method of shipment indicated.



**NOTE:** If packing unit for return shipment, DO NOT use styrofoam "peanuts."

# WARRANTY

---

Sonics & Materials, Inc., hereinafter referred to as "Sonics", warrants its products for a period of one year from the date of original shipment against defects in materials and workmanship under normal installation, use and maintenance as described in the operating instructions which accompany such equipment. During the warranty period, Sonics will, at its option, as the exclusive remedy, either repair or replace without charge for material and labor, the part(s) which prove upon our examination to be defective, provided the defective unit is returned to us properly packed with all transportation charges F.O.B. Sonics dock, Newtown, CT. Warranty period on equipment rentals that are converted to purchase are deemed to have commenced on the date of original rental equipment shipment.

Ultrasonic plastics welding horns constructed of titanium or aluminum are guaranteed against defects for a period of one year from date of shipment. Sonics will repair or replace a cracked or defective horn once without charge, if failure occurs within the warranty period.

Ultrasonic plastics welding horns constructed of steel are guaranteed against defects for a period of ninety days from date of shipment. Sonics will repair or replace a cracked or defective steel horn once at a charge of 50% of the original purchase price, if failure occurs within the warranty period.

Ultrasonic metal welding horns constructed of titanium or steel are guaranteed against defects for a period of one year from date of shipment. Sonics will repair or replace a cracked or defective horn once without charge, if failure occurs within the warranty period.

Sonics warrants its ultrasonic converters for a period of one year from date of shipment with a one-time replacement if a converter proves to be non-repairable.

When customer site service is required, all travel, living and related expenses will be billed at cost. In-warranty service labor time (including travel time) at the customers facility is provided Monday through Friday (excluding holidays) from 8:00 am to 5:00 pm. Any in-warranty service time requested outside of these days and hours will be billed at 150% of Sonics current rate per hour for such site service work.

## **LIMITATION OF WARRANTY**

This warranty does not apply to items subject to normal wear and tear or, to equipment or tooling which has been subject to unauthorized repair, misuse, abuse, negligence or accident. Misuse includes operation of equipment with tooling that is not qualified for the equipment or tooling not properly installed on the equipment.

Equipment which, in our judgment, shows evidence of having been used in violation of operating instructions, or which has had the serial number altered or removed, will be ineligible for service under this warranty.





For components and parts not manufactured by Sonics but included in Sonics manufactured equipment, this warranty shall be limited to the warranty as given to Sonics by said original component or part manufacturer.

Ultrasonic horns supplied by Sonics are manufactured to exacting specifications and are tuned to vibrate at a specific frequency. Using an out-of-tune horn will cause damage to the equipment and may result in warranty nullification. Sonics assumes no responsibility for converters, horns or fixtures not supplied by Sonics or for consequential damages resulting from their usage.

Ultrasonic converters showing signs of excessive heat or contamination, such as but not limited to, oils and moisture, are not covered by this warranty.

Warranty does not apply to ultrasonic horns quoted as prototype, experimental or of unusual design which, in our judgment are more likely to fail in use.

Warranty does not apply to re-sharpening of ultrasonic blade type cutting or slitting horns.

Warranty does not apply to knurl pattern wear on ultrasonic plastics and metal welding horns and tips.

Warranty does not apply to ultrasonic horn or tip face wear when used with plastics that are molded with fillers, such as but not limited to, glass or talc.

This warranty does not apply to ultrasonic plastics welding equipment, horns or fixtures where metal-to-metal tooling contact time is in excess of 250 milliseconds.

This warranty does not apply to used or re-built equipment.

This warranty is non-transferable.

Data supplied in Sonics instruction manuals has been verified and validated and is believed adequate for the intended use of the equipment. If the equipment or procedures are used for purposes other than those specified herein, confirmation of their validity and suitability should be obtained in writing from Sonics. Otherwise Sonics does not guarantee results and assumes no obligation or liability.

This warranty is in lieu of any other warranties, either express, implied, or statutory. Sonics neither assumes nor authorizes any person to assume for it any other obligation or liability in connection with the sale of its products. Sonics hereby disclaims any warranty or merchantability or fitness for a particular purpose. No person or company is authorized to change, modify, or amend the terms of this warranty in any manner or fashion whatsoever. Under no circumstances shall Sonics be liable to the purchaser or to any other person for any incidental or consequential damages or loss of profit or product resulting from any malfunction or failure of this Sonics product.



# APPENDIX

## PRINT LINE OUTPUT DATA ITEMS

**Item 1:** Using the first line of the sample listing above, item 1 is the “Customer Resettable Counter” (CRC). It is located at position 1 through position 6 so the value of 005647 indicates that the last cycle was weld number 5647 since the last time it was reset to 0 (see page 18).

```
005647 00.48 sec 0.025 in 000130 J 045 %Pmax Alarms T:-- D:-- E:-- J06 -----
```

**Item 2:** The second item sent is the actual weld time from the last cycle – the time that the ultrasonic generator was running. So 00.48 means that the generator was ON for .48 seconds. If the weld cycle finished its programmed weld time, then the following “sec” would have been transmitted as upper case letters or “SEC.” The “sec” is lower case so the weld cycle was terminated through some other parameter. The time data is located at positions 8 through 12 and includes the “.” at position 10. The “sec” label is located at position 14 through position 16. Space characters are located at positions 7, 13 and 17.

```
005647 00.48 sec 0.025 in 000130 J 045 %Pmax Alarms T:-- D:-- E:-- J06 -----
```

**Item 3:** Next is the distance data. Distance controls are not available on Model GXT, so the Distance data will always appear as 0.000 in or 00.00 mm.

```
005647 00.48 sec 0.000 in 000130 J 045 %Pmax Alarms T:-- D:-- E:-- J06 -----
```

**Item 4:** Next is the energy data. Energy controls are not available on Model GXT, so the Energy data will always appear as 000000J.

```
005647 00.48 sec 0.025 in 000000 J 045 %Pmax Alarms T:-- D:-- E:-- J06 -----
```

**Item 5:** The maximum percent power number is next in line at positions 36 through 38 with a space at 39. This number is the maximum percent of power developed during the last weld cycle. The label “%Pmax” does not change case as the control items can for time, distance (Model GXL only) and energy. It is not a control parameter, just a label for text readability.

```
005647 00.48 sec 0.025 in 000130 J 045 %Pmax Alarms T:-- D:-- E:-- J06 -----
```

**Item 6:** Any alarm violations for time, distance (Model GXL only) or energy (Model GXE only) will be sent in the following positions as L or H in place of the "--" shown in the sample line. The dashes are used to hold the place when there are no alarm items so the "T:-- D:-- E:--" reading indicates that there were no alarms during the last weld cycle. (Distance and Energy controls are not available on Model GXT so those alarms will always print as "D:-- and E:--.") The low alarm, high alarm order is always the same for time, distance and energy (examples: T:L- T:-H or T:LH ). Time alarms are at positions 57 and 58; distance at positions 62 and 63; and energy at positions 67 and 68. Note that it is possible for a weld cycle to have both high and low alarms at the same time depending on the alarm settings (see page 17). High and Low alarms are set and examined independently.

005647 00.48 sec 0.025 in 000130 J 045 %Pmax Alarms T:-- D:-- E:-- J06 -----

**Item 7:** The next item represents the last job number that was saved or recalled from the job storage memory. There are 15 jobs numbered 1 through 15 so this item is transmitted as 01 through 15 or "--" if job data has not been set (first power up). The "J" label is used for readability of the job data number. When an automation system is using the remote job change option between weld cycles, the print line can be used as verification of the recalled job for the last weld cycle. The job data number is located at position 71 through 72.

005647 00.48 sec 0.025 in 000130 J 045 %Pmax Alarms T:-- D:-- E:-- J06 -----

**Item 8:** The last printable item on the line is a comment position used to indicate that a weld cycle was terminated by one of several external causes. Dashes in these positions will be the normal output when the weld cycle is controlled by weld parameter settings. Four external conditions may be indicated at the end of the line in positions 74 through 78: "Xstop" indicates an external stop signal was received (the cutoff command), "MnClr" when the cycle is stopped because the operator pressed the Clear key during the weld; "Ovrd" if the system aborts due to ultrasonic overload; and "CkLim" if the cycle has aborted because the preweld limits failed to find the parts at the proper position. CkLim will only apply when the distance control is ON (system was purchased with the distance encoder option – Model GXL).

**Speed Consideration:** If ultimate speed is more important to an application or the system is not using the print line output, it may be turned off with a switch on the internal processor board behind the front panel. Switch 5 is normally set OFF, to prevent the system from sending the print line (the factory default setting). Turn switch 5 ON to have the print line transmitted after each cycle. The system will respond to the automation start command (impulse) more quickly with the print line OFF because the message line will not be compiled or transmitted in this case.

WWW.QOOVIA-HK.COM



## AUTOMATION INTERFACE & I/O CONTROLS

### SOURCE/SINK INPUTS AND OUTPUTS

Vendor terminology and specifications can be confusing as the reference is easily misinterpreted. Does the vendor send a “Sourcing” signal or do they mean that an input is ready to receive (or sink) current from an external source? Some PLC vendors seem to contradict others and the applications engineer ends up with a bank of relays or pull up/down resistors to switch the signal type.

When the optical IC is placed into socket U42, the G series outputs (Ready, Good Part, Bad Part, and the Spare DO) are configured as “Sourcing.” The isolated transistor collectors must be connected to an external loop supply (all 4 collectors are connected together; signal name +VDC Source (Input); pin 18 on I/O Connector J3; cable wire – orn/red). Some PLC’s provide a DC supply for this purpose, some applications will require a separate supply.

When the G series output is true or ON, current from the loop supply is conducted through the output transistor and limiting 100 ohm resistor to the PLC input card which returns to the loop supply. The PLC input will be ON if the current is flowing and OFF if the G series output is false or OFF.

Inputs (DI1-DI4) also set for "Source" as factory default.

*See schematic drawing on page 40 for more detail.*

## SOURCE/SINK DIGITAL I/O CONFIGURATION

The digital inputs and outputs are configured by moving two IC's on the control circuit board located directly behind the front panel. Be sure that the power is OFF and then remove the top cover. The components may be moved using a small screwdriver to pry the IC's from the socket strips. Select the "Source" or "Sink" location and reinstall the components. They are not required to be set the same – one may be "Source" and the other "Sink" to best match the required interface signals.

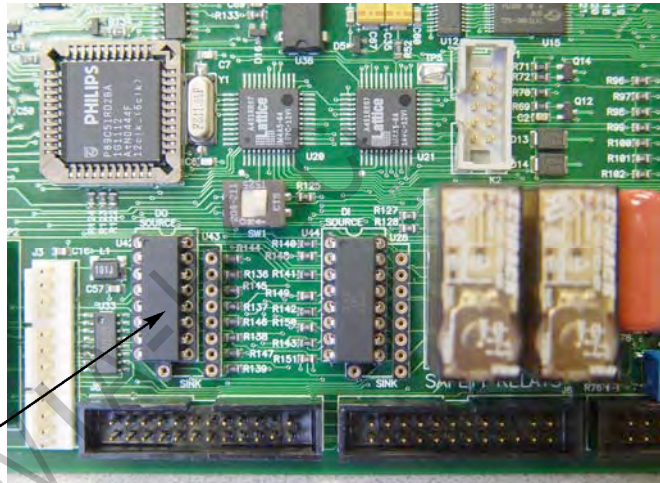

The optical isolator for the Digital Outputs (DO) is shown in the default "Source" configuration.

The outputs may be switched to "Sink" by moving this IC to the alternate location as shown below.

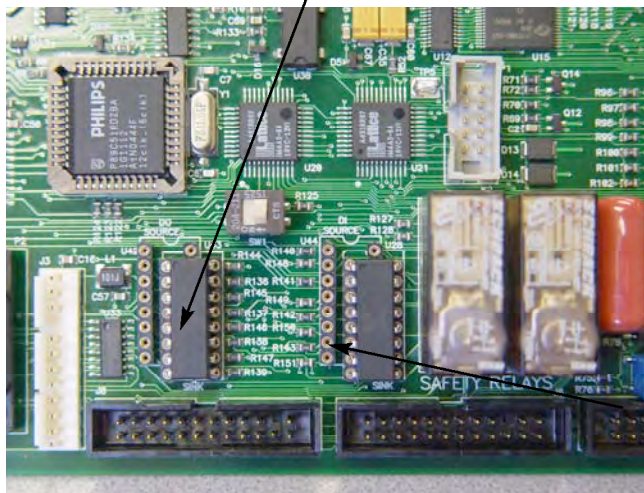

The digital inputs may be reconfigured in the same manner. They are also set for "Source" as the factory default as shown above.

Digital Inputs shown configured for "Sink."

### **SINKING OUTPUT TO PLC INPUT DIAGRAM**

When the optical IC is placed into socket U43, the G series outputs are configured as “Sinking.” The isolated transistor emitters must be connected to the return line of the loop supply (all 4 emitters are connected together; signal name Voltage Sink Return (output); pin 19 on I/O Connector J3; cable wire – blu/red).

When the G series output is true or ON, current from the loop supply is conducted through the PLC input card, the G series output transistor and 100 ohm limiting resistor to the loop supply return line.

*See schematic drawing on page 41 for more detail.*

### **PLC OUTPUT TO SINKING INPUT DIAGRAM**

When the optical IC for input configuration is placed into socket U28, the G series inputs (DI1, DI2, DI3, DI4) are configured to receive a “Sinking” input, a pull down transistor or relay contact to the loop return. The anodes of the input LEDs must be connected to a user supplied loop supply; +30 VDC max (all 4 LED anodes are connected together; signal name +VDC Sink-Input; pin 12 on I/O Connector J3; cable wire – black/white).

When the PLC output is true or ON, current from the loop supply is conducted through the G series opto LED and 2.4 kohm limiting resistor to the PLC output card which returns to the loop supply. If the PLC output is ON (conducting), the current is returned to the loop return line and the input is true or ON. If the PLC output is OFF the G series input is false or OFF.

*See schematic drawing on page 42 for more detail.*

### **PLC OUTPUT TO SOURCING INPUT DIAGRAM**

When the optical IC for input configuration is placed into socket U44, the G series inputs are configured to receive a “Sourcing” input, a high side transistor or relay contact to the positive loop supply. The cathode side of the input LEDs must be connected to the return line of the loop supply (all 4 cathodes are connected together; signal name Voltage Source Return – input; pin 13 on I/O Connector J3; cable wire – red/white).

When the PLC output is true or ON, current from the loop supply is conducted through the PLC output element to the G series input opto LED and limiting 2.4 kohm resistor to the return of the loop supply. If the PLC output is ON (conducting) the G series input is true or ON. If the PLC output is OFF the G series input is false or OFF.

*See schematic drawing on page 43 for more detail.*

## **TWO ISOLATED LOOP SUPPLIES**

Two isolated non-regulated 24 VDC supplies (50 ma max) are available on the digital I/O connector and may be used for the I/O loop power. These are low level supplies and cannot be used to power relay inputs or outputs! They should be used for LED indicators or transistor type input cards if the PLC does not provide low level DC power for this purpose.

The first supply is available on connector J3 pin 1 (+24 VDC isolated supply #1; cable wire – black) and J3 pin 2 (+24 VDC isolated supply return #1; cable wire – white). The second supply is on J3 pin 3 (+24 VDC isolated supply #2; cable wire – red) and J3 pin 4 (+24 VDC isolated supply return #2; cable wire – green).

*See schematic drawing on page 44 for more detail.*

## **I/O TIMING DIAGRAM – AUTOMATION CONTROLS**

The cycle begins with the impulse contact to start a cycle (note that the impulse signal is not part of the configurable inputs and outputs for compatibility with existing product lines). If the system is using external job selection, the job address lines must be stable 50 ms prior to the impulse contact and remain stable until the cycle is underway as indicated by Ready going low (false). The Good Part/Bad Part lines are also cleared as the cycle begins.

When the weld cycle is complete, the Good or Bad part signal is set prior to the system returning to the ready condition. The impulse (and Palm Button signals) must all be released to complete a cycle and return the Ready Signal.

*See schematic drawing on page 45 for more detail.*



## PLC SAMPLE CODE

The following ladder file is a simple demonstration routine to roll the external job selection from job 1 through 15 then restart at job 1 again. This routine will switch jobs as fast as possible because the next job code is generated and set during the previous weld cycle. The job is ready before the previous cycle is completed.

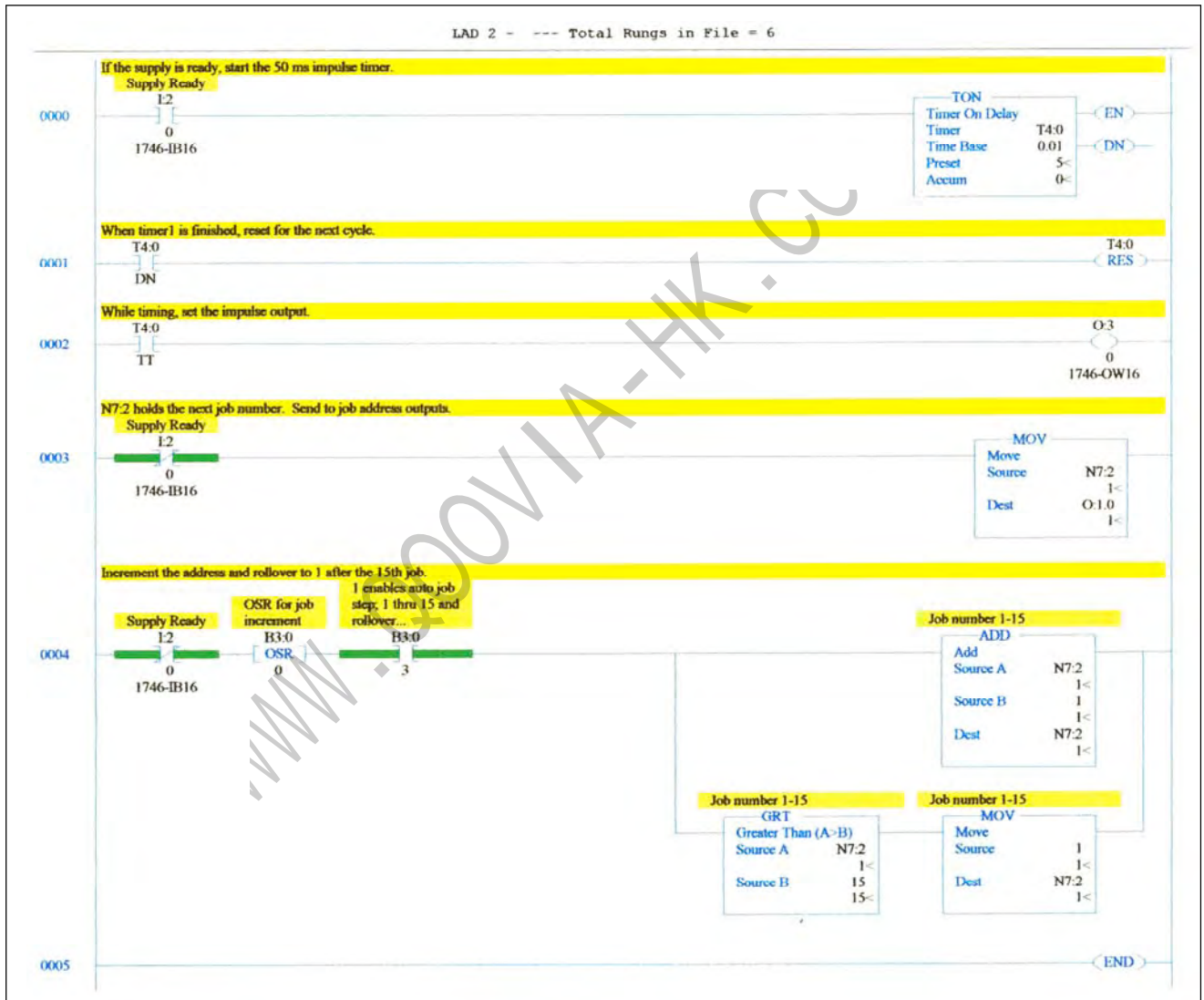

When the ultrasonic supply is READY a timer is started to generate the 50 ms impulse command in rung 0. When the timer is finished it will be reset by rung 0001 so it will be ready to go as soon as the cycle is completed and ready returns true.

While the timer is timing, output O:3/0 is set causing the ultrasonic system to begin a new cycle. This is the 50 ms impulse signal (rung 0002).

Once the new cycle has started, the ready signal will be false and the next job number is sent to the output at output O:1.0. So the address code for the next cycle is set and stable long before the present cycle is completed (rung 0003).

Rung 0004 generates the next job address code and updates the holding register, N7:2, with the next job number. If the number is greater than 15, it gets reset to 1 to start over.

This sample runs round and round as fast as possible limited by the application time settings, the ultrasonic press movement (gap to the fixture and parts) and travel distance. Over 80 weld cycles per minute are possible with very short weld times, higher pressures and shorter press stroke settings.

### G series Digital Outputs (DO)

The GX digital outputs are optically isolated from the internal circuits. Each transistor is rated for 30 VDC max @ 100 ma max; an internal 100 ohm limiting resistor is provided in each transistor output. Do NOT apply AC voltage!

Source Outputs are the default configuration as shipped from the factory. They may be switched to "Sink" if desired. See Section x.xx, "Source/Sink Digital I/O Configuration"

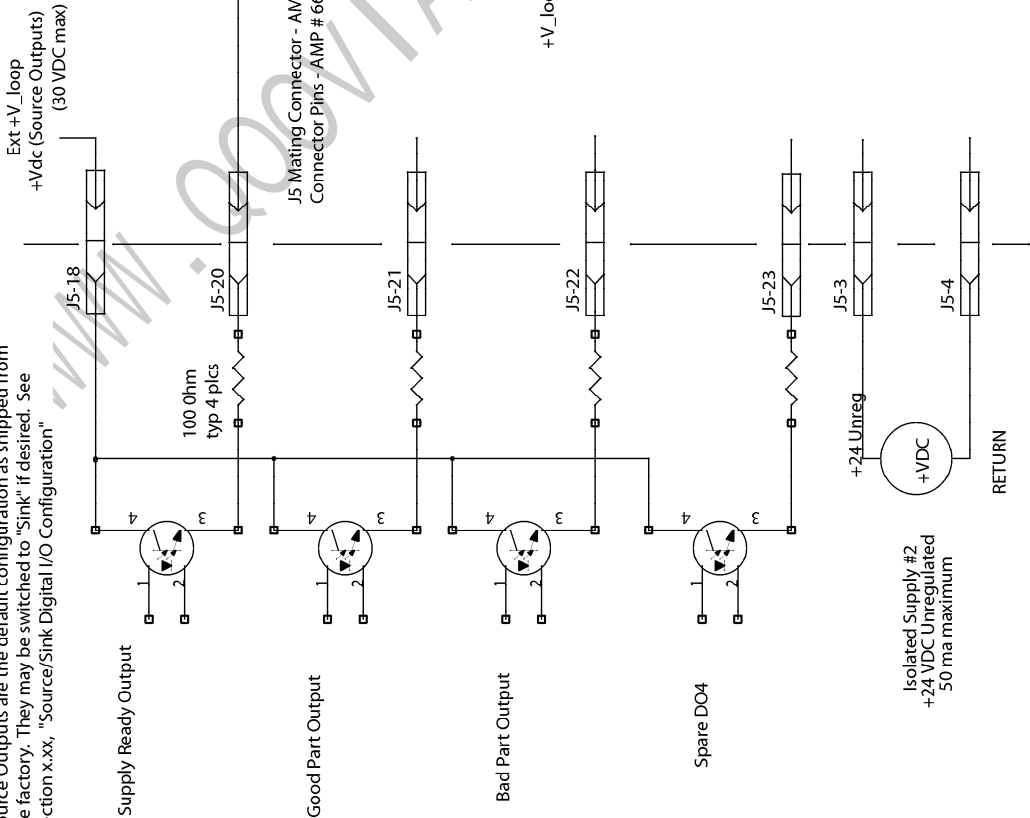

### PLC Input Card - typical 4 places

An external loop supply is required to power the output circuit (normally provided by the PLC system). Alternatively, 2 isolated, unregulated, 24 VDC supplies are available on the GX supply (J5 connector). These supplies are NOT regulated and only rated for 50 ma total.

Typical 4 Places

		53 CHURCH HILL RD. NEWTOWN, CT 06470	
<b>SOURCING OUTPUTS TO PLC INPUT DIAGRAM</b>			
DRAWN BY		DRAWING NO.	
WPS		E-3167	
CHKD		DATE	
10-12-05			
MATERIAL			
FRACTIONAL		SCALE	
+/- 1/64			
ANGULAR		DATE	
+/- 1/2 DEG.			
CONFIDENTIAL INFORMATION			
THE INFORMATION AND DATA CONTAINED HEREIN IS PROPRIETARY AND IS SUBMITTED IN CONFIDENCE, AND SHALL NOT BE DISCLOSED, USED OR REPRODUCED FOR ANY PURPOSE WHATSOEVER WITHOUT THE PRIOR WRITTEN PERMISSION OF SONICS & AMERIBASIC, INC., NEWTOWN, CT. THIS LEGEND SHALL BE REMAINED ON ANY REPRODUCTIONS HEREOF IN WHOLE OR IN PART. RECEIPT OF THIS DOCUMENT SHALL BE DEEMED TO BE AN ACCEPTANCE OF THE CONDITIONS SPECIFIED HEREIN.			

TOLERANCES  
(EXCEPT AS NOTED)

DECIMAL  
X= +/-0.030  
XX= +/-0.015  
XXX= +/-0.005

FRACTIONAL  
+/- 1/64

ANGULAR  
+/- 1/2 DEG.

## G series Digital Outputs (DO)

The GX digital outputs are optically isolated from the internal circuits. Each transistor is rated for 30 VDC max @100 ma max; an internal 100 ohm limiting resistor is provided in each transistor output. Do NOT apply AC voltage!

Source Outputs are the default configuration as shipped from the factory. They may be switched to "Sink" if desired. See Section x.xxx, "Source/Sink Digital I/O Configuration"

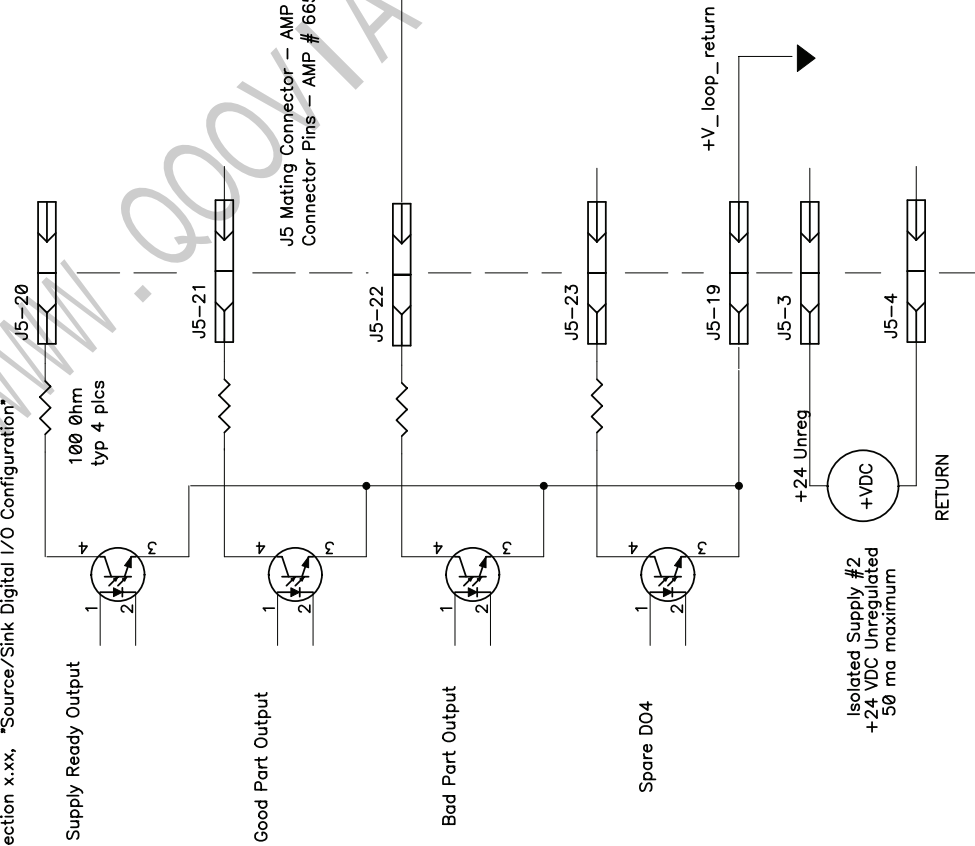

## PLC Input Card – typical 4 places

An external loop supply is required to power the output circuit (normally provided by the PLC system). Alternatively, 2 isolated, unregulated, 24 VDC supplies are available on the GX supply (J5 connector). These supplies are NOT regulated and only rated for 50 ma total.

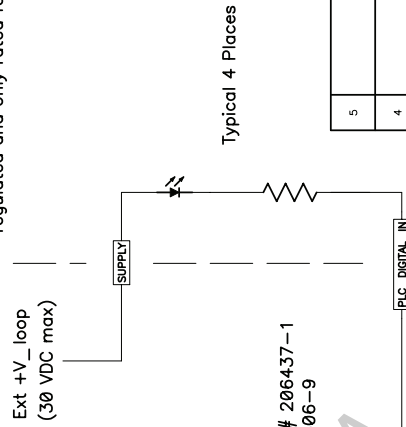

Typical 4 Places

NO.	DESCRIPTION	BY	DATE
5			
4			
3			
2			
1	Changed J5-18 to J5-19	BP	12/2/08

		53 CHURCH HILL RD. NEWTOWN, CT 06470	
<b>SINK OUTPUTS TO PLC INPUT DIAGRAM</b>		DRAWING NO. <b>E-3169</b>	
TOLERANCES (EXCEPT AS NOTED)		DRAWN BY WPS	SCALE
DECIMAL .X= +/-0.030 .XX= +/-0.015 .XXX= +/-0.005		CHECK'D DATE 10-20-05	MATERIAL
FRACTIONAL +/- 1/64		CONFIDENTIAL INFORMATION THE INFORMATION AND DATA CONTAINED HEREIN IS PROPRIETARY AND IS SUBMITTED IN CONFIDENCE AND SHALL NOT BE DISCLOSED, USED OR DUPLICATED FOR ANY PURPOSE WHATSOEVER WITHOUT THE PRIOR WRITTEN PERMISSION OF SONICS & MATERIALS, INC. NEWTOWN, CT. THIS LEGEND SHALL BE MARKED ON ANY REPRODUCTIONS HEREOF IN WHOLE OR IN PART. RECEIPT OF THIS DOCUMENT SHALL BE DEEMED TO BE AN ACCEPTANCE OF THE CONDITIONS SPECIFIED HEREIN.	
ANGULAR +/- 1/2 DEG.			

## PLC Output Card

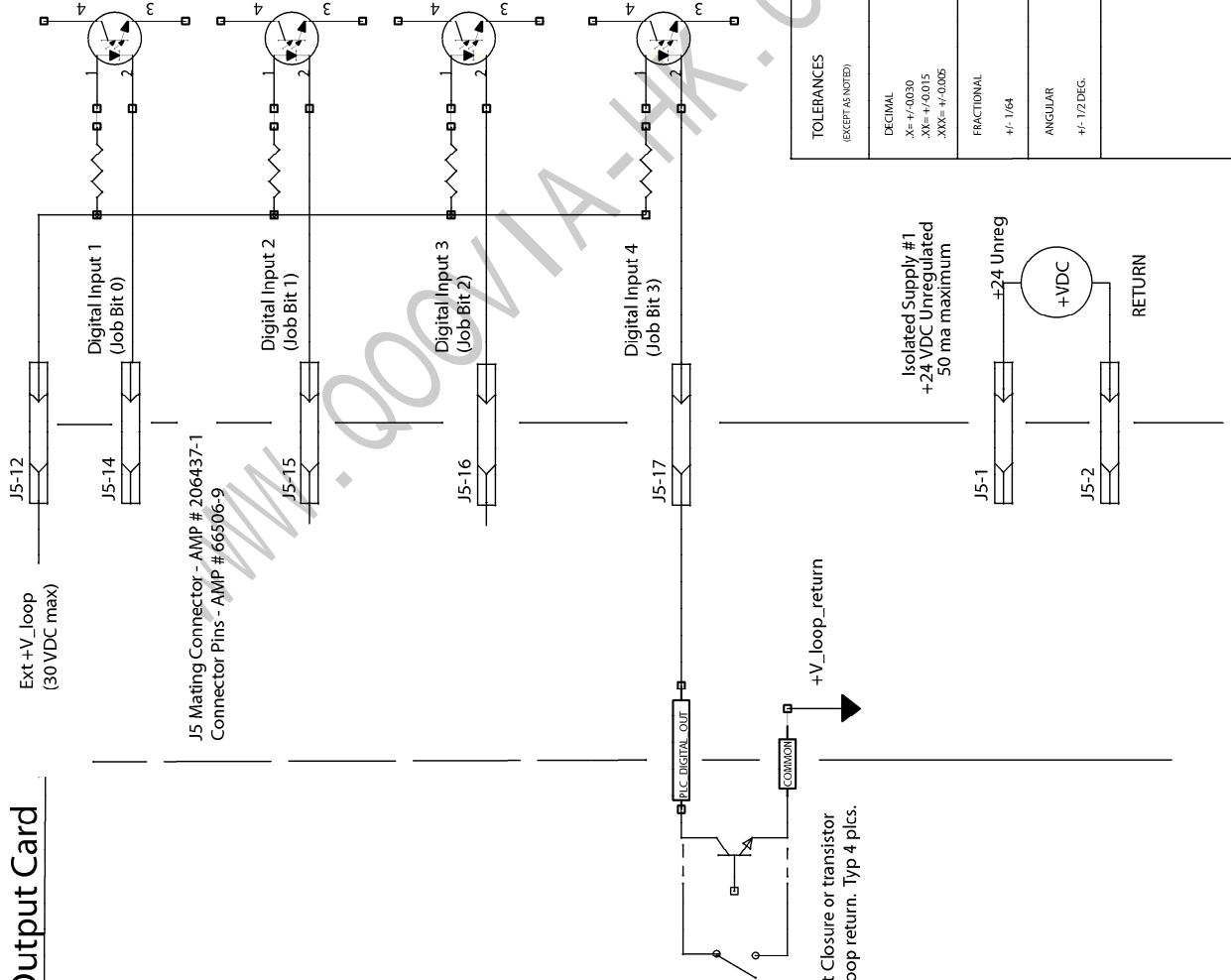

## G series Digital Inputs(DI)

The GX digital inputs are optically isolated from the internal circuits. An internal 2.4 K limiting resistor is provided for each optical input. Do NOT apply AC voltage!

Source Inputs are the default configuration as shipped from the factory. They may be switched to "Sink" if desired. See Section xxx, "Source/Sink Digital I/O Configuration"

An external loop supply is required to power the input circuit (normally provided by the PLC system). Alternatively, 2 isolated, unregulated, 24 VDC supplies are available on the GX supply (J5 connector). These supplies are NOT regulated and only rated for 50 ma total.

		53 CHURCH HILL RD. NEWTOWN, CT 06470	
<b>PLC OUTPUT TO SINKING INPUT DIAGRAM</b>			
DRAWN BY: WPS		DRAWING NO.: E-3170	
CHKD:		DATE: 10-12-05	
MATERIAL:		SCALE:	
TOLERANCES (EXCEPT AS NOTED)		CONFIDENTIAL INFORMATION	
DECIMAL X= +/-0.030 XX= +/-0.015 XXX= +/-0.005		THE INFORMATION AND DATA CONTAINED HEREIN IS PROPRIETARY AND IS SUBMITTED IN CONFIDENCE, AND SHALL NOT BE DISCLOSED OR REPRODUCED FOR ANY PURPOSE, WITH OR WITHOUT THE PRIOR WRITTEN PERMISSION OF SONICS & TEREBAS, INC., NEWTOWN, CT. THIS LEGEND SHALL BE MAINTAINED ON ALL REPRODUCTIONS HEREOF IN WHOLE OR IN PART. REC. OF THIS DOCUMENT SHALL BE DEEMED TO BE AN ACCEPTANCE OF THE CONDITIONS SPECIFIED HEREIN.	
FRACTIONAL +/- 1/64		ANGULAR +/- 1/2 DEG.	

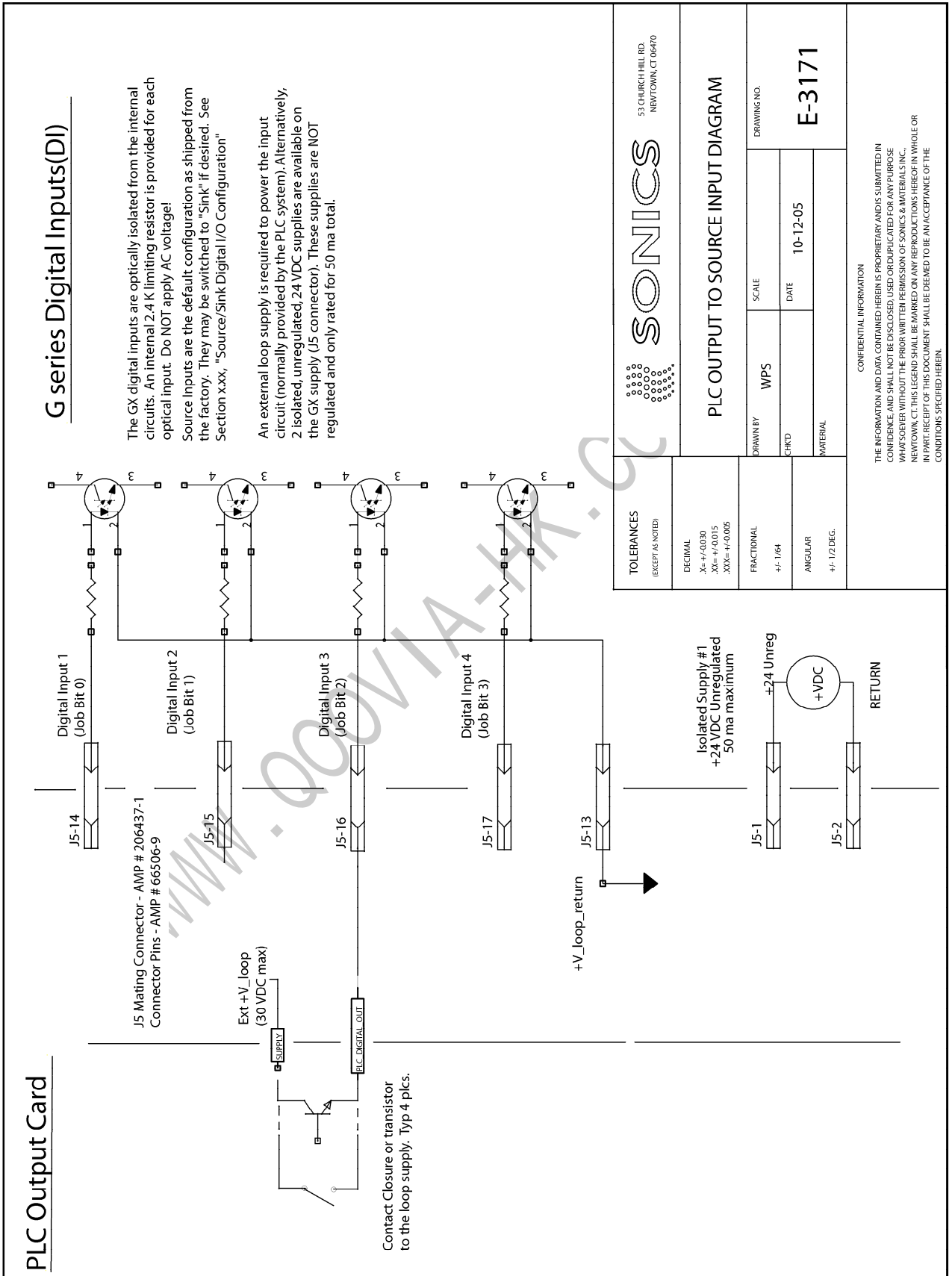

POWER SUPPLY CONNECTOR		CUSTOMER I/O CONNECTIONS	
1	BLACK	+24VDC ISOLATED SUPPLY #1	
2	WHITE	+24VDC ISOLATED SUPPLY RETURN #1	
3	RED	+24VDC ISOLATED SUPPLY #2	
4	GREEN	+24VDC ISOLATED SUPPLY RETURN #2	
5	ORANGE	SPARE DIGITAL INPUT	
6	BLUE	GROUND	
7	WHITE/BLACK	N.C.	
8	RED/BLACK	N.C.	
9	GREEN/BLACK	N.C.	
10	ORANGE/BLACK	N.C.	
11	BLUE/BLACK	N.C.	
12	BLACK/WHITE	+VDC (SINK INPUTS)	
13	RED/WHITE	RETURN (SOURCE INPUTS)	
14	GREEN/WHITE	DIGITAL INPUT #1 (JOB BIT 0)	
15	BLUE/WHITE	DIGITAL INPUT #2 (JOB BIT 1)	
16	BLACK/RED	DIGITAL INPUT #3 (JOB BIT 2)	
17	WHITE/RED	DIGITAL INPUT #4 (JOB BIT 3)	
18	ORANGE/RED	+VDC (SOURCE OUTPUTS)	
19	BLUE/RED	RETURN (SINK OUTPUTS)	
20	RED/GREEN	DIGITAL OUTPUT (READY SIGNAL)	
21	ORANGE/GREEN	DIGITAL OUTPUT (GOOD PART SIGNAL)	
22	BLACK/WHITE/RED	DIGITAL OUTPUT (BAD PART SIGNAL)	
23	WHITE/BLACK/RED	DIGITAL OUTPUT (SPARE #4)	
24	RED/BLACK/WHITE	N.C.	
25	GREEN/BLACK/WHITE	N.C.	
26	ORANGE/BLACK/WHITE	EXTERNAL AMPLITUDE CONTROL (0-10VDC = 20-100% AMPLITUDE) ISOLATED SUPPLY (SEE NOTE 5)	
27	BLUE/BLACK/WHITE	OVERLOAD INDICATION (SEE NOTE 3)	
28	BLACK/RED/GREEN	COMMON EMITTER	
29	WHITE/RED/GREEN	OVERLOAD RESET (SEE NOTE 4)	
30	RED/BLACK/GREEN	GROUND	
31	GREEN/BLACK/GREEN	TUNE LOCK (SEE NOTE 6)	
32	ORANGE/BLACK/GREEN	FREQUENCY/10 (SEE NOTE 7)	
33	BLUE/WHITE/ORANGE	SWPS READY SIGNAL (SEE NOTE 9)	
34	BLACK/WHITE/ORANGE	WANTS OUTPUT: 0-10VDC = 0-100% (SEE NOTE 6)	
35	WHITE/RED/ORANGE	N.C.	
36	ORANGE/WHITE/BLUE	N.C.	
37	WHITE/RED/BLUE	N.C.	
38	BLACK/WHITE/GREEN	N.C.	
39	WHITE/BLACK/GREEN	N.C.	
40	RED/WHITE/GREEN	N.C.	
41	GREEN/WHITE/BLUE	N.C.	
42	ORANGE/RED/GREEN	N.C.	
43	BLUE/RED/GREEN	N.C.	
44	BLACK/WHITE/BLUE	N.C.	
45	WHITE/BLACK/BLUE	N.C.	
46	RED/WHITE/BLUE	N.C.	
47	GREEN/ORANGE/RED	N.C.	
48	ORANGE/RED/BLUE	N.C.	
49	BLUE/RED/ORANGE	N.C.	
50	BLACK/ORANGE/RED	N.C.	
51	N.C.	N.C.	
52	N.C.	N.C.	
53	N.C.	N.C.	
54	N.C.	N.C.	
55	N.C.	N.C.	
56	N.C.	N.C.	
57	N.C.	CABLE SHIELD (EARTH)	

**CONNECTION NOTES:**

- +24VDC ISOLATED SUPPLIES MAX RATING 1A/100VDC UNREGULATED 500mA MAX
- +24VDC ISOLATED SUPPLY RETURNS ON PINS 2&4 NOT COMMON TO GROUND ON PIN 6, OR PIN 30.
- OVERLOAD INDICATOR - 30VDC; 200mA MAX. NPN OPEN COLLECTOR TRANSISTOR OUTPUT (TO COMMON EMITTER PIN 28) NO INTERNAL CURRENT LIMIT.
- TRANSISTOR ON= POWER SUPPLY IS IN OVERLOAD CONDITION. OVERLOAD RESET MOMENTARY CONTACT CLOSURE TO GROUND (MIN 200ms), SWITCH OR RELAY CONTACT 30VDC; 200mA MAX BETWEEN PIN 29 AND PIN 30.
- EXTERNAL AMPLITUDE 200mA MAX, 0-10VDC ISOLATED VOLTAGE SOURCE (0-10VDC = 20-100% AMPLITUDE)
- WANTS OUTPUT- DC VOLTAGE OUTPUT TO GROUND (0-10VDC = 0-100% RATED OUTPUT)\*
- \* FOR GXC/GXP MODELS DC VOLTAGE OUTPUT (0-8.16 = 0-100% RATED OUTPUT)
- FREQUENCY/10 - 30VDC; 200mA MAX. NPN OPEN COLLECTOR TRANSISTOR OUTPUT (TO COMMON EMITTER PIN 28). NO INTERNAL CURRENT LIMIT
- TUNE LOCK - 30VDC; 200mA MAX. NPN OPEN COLLECTOR TRANSISTOR OUTPUT (TO COMMON EMITTER PIN 28). NO INTERNAL CURRENT LIMIT
- SWPS READY- 30VDC 200mA MAX. NPN OPEN COLLECTOR TRANSISTOR OUTPUT (TO COMMON EMITTER PIN 28). NO INTERNAL CURRENT LIMIT
- TRANSISTOR ON= PULL/CONTROL BD. READY

NO.	DESCRIPTION	BY	DATE
5			
4			
3			
2			
1	REF. ECN #689, INCREASED COND. FROM 25 TO 50 FOR ADDED SIGNALS.	BP	12-6-96

FILE # E\_3164.SCH

		52 SUTTON HILL DR. SHAVANNA, CT 06470	
<b>GX-SERIES CONTROLLER EXTERNAL I/O CONNECTIONS</b>			
DRAWN BY	SCALE	DATE	DRAWING NO.
BP		7-14-05	E-3164
CHKD			
MATERIAL			

TOLERANCES (UNLESS OTHERWISE SPECIFIED):  
 DECIMAL: .0004  
 FRACTIONAL: 1/16  
 ANGULAR: 1/2 DEG.

CONFIDENTIAL INFORMATION  
 THE INFORMATION AND DATA CONTAINED HEREIN IS PROPRIETARY AND IS SUBMITTED IN CONFIDENCE, AND SHALL NOT BE DISCLOSED, USED OR REPRODUCED FOR ANY PURPOSE WHATSOEVER WITHOUT THE PRIOR WRITTEN PERMISSION OF SONICS & MATERIALS INC. IN THE EVENT THAT THIS DOCUMENT IS REPRODUCED OR TRANSMITTED IN ANY FORM OR BY ANY MEANS, IN PART OR IN WHOLE, WITHOUT THE WRITTEN PERMISSION OF SONICS & MATERIALS INC., THE USER SHALL BE DEEMED TO BE IN ACCEPTANCE OF THE CONDITIONS SPECIFIED HEREIN.

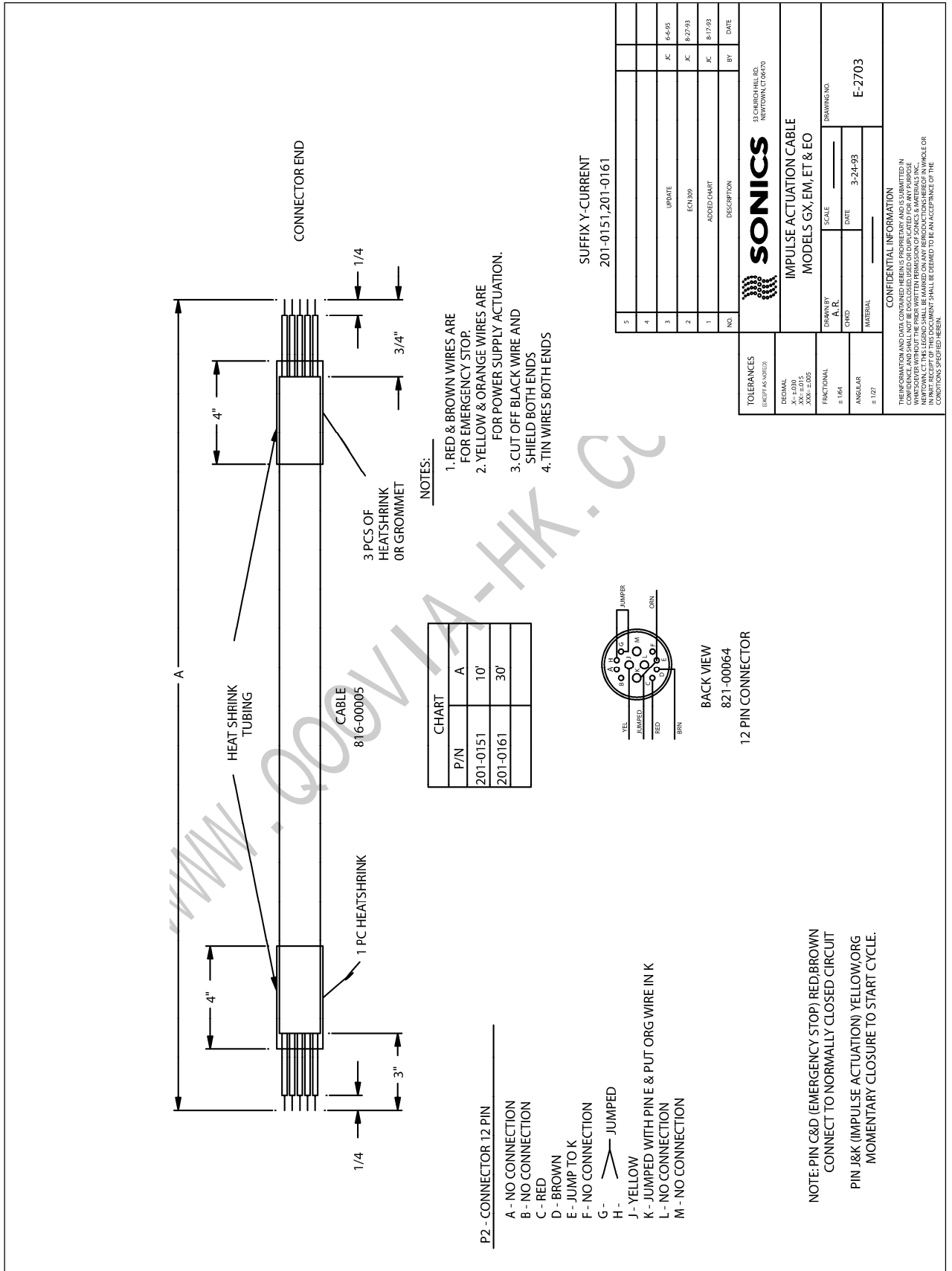

5			
4			
3	UPDATE	J.	6-6-95
2	ECN-389	K.	8-27-93
1	ADDRESS CHART	K.	8-27-93
NO.	DESCRIPTION	BY	DATE

31 CHURCH HILL RD. NEWTOWN, CT 06470	
<b>IMPULSE ACTUATION CABLE</b> MODELS GX, EM, ET & EO	
DESIGNED BY	SCALE
DRAWN BY	DATE
CHECKED	DATE
MATERIAL	DATE
DRAWING NO. E-2703	

**CONFIDENTIAL INFORMATION**

THE INFORMATION AND DATA CONTAINED HEREIN IS UNCLASSIFIED AND IS NOT TO BE RELEASED OR DISCLOSED IN ANY MANNER WITHOUT THE PRIOR WRITTEN PERMISSION OF SONICS & AMBERALS, INC. ANY UNAUTHORIZED DISCLOSURE OF THIS INFORMATION IS STRICTLY PROHIBITED. IN PART RECEIPT OF THIS DOCUMENT SHALL BE DEEMED TO BE AN ACCEPTANCE OF THE CONDITIONS SPECIFIED HEREIN.



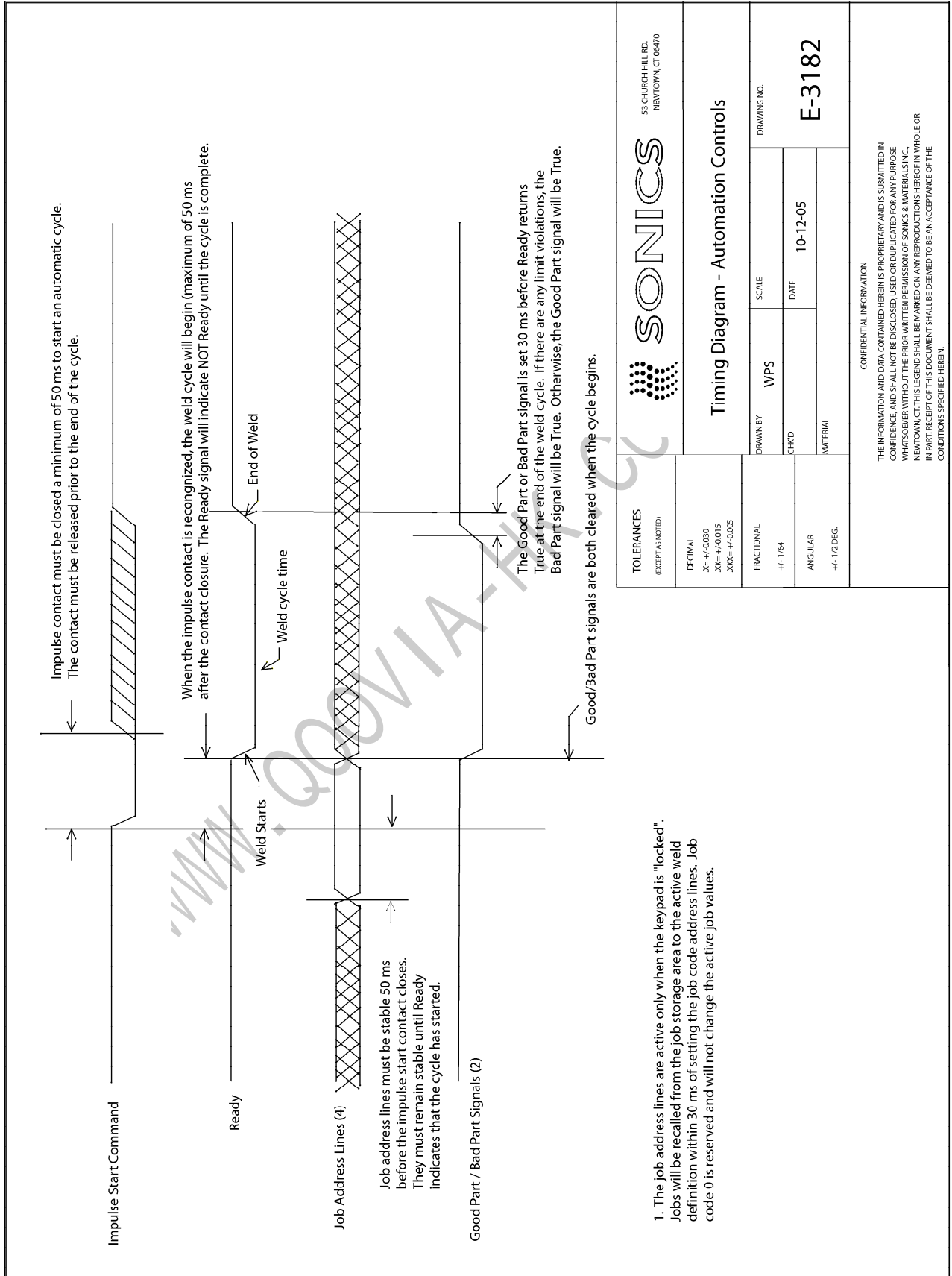

1. The job address lines are active only when the keypad is "locked". Jobs will be recalled from the job storage area to the active weld definition within 30 ms of setting the job code address lines. Job code 0 is reserved and will not change the active job values.

		53 CHURCH HILL RD. NEWTOWN, CT 06470	
<b>Timing Diagram - Automation Controls</b>			
TOLERANCES (EXCEPT AS NOTED)		DRAWN BY WPS	DRAWING NO. E-3182
DECIMAL .X = +/-0.030 .XI = +/-0.015 .XIX = +/-0.005		SCALE	DATE 10-12-05
FRACTIONAL +/- 1/64		CHK'D	MATERIAL
ANGULAR +/- 1/2 DEG.		CONFIDENTIAL INFORMATION THE INFORMATION AND DATA CONTAINED HEREIN IS PROPRIETARY AND IS SUBMITTED IN CONFIDENCE, AND SHALL NOT BE DISCLOSED OR REPRODUCED FOR ANY PURPOSE, WITHOUT THE PRIOR WRITTEN PERMISSION OF SONICS & MATERIALS, INC., NEWTOWN, CT. THIS LEGEND SHALL BE MARKED ON ANY REPRODUCTIONS HEREOF IN WHOLE OR IN PART. RECEIPT OF THIS DOCUMENT SHALL BE DEEMED TO BE AN ACCEPTANCE OF THE CONDITIONS SPECIFIED HEREIN.	

Start Weld Cycle

- Start a Weld Cycle by impulse or palm button command contacts.
- The Ready , the Good Part and the Bad Part signals are all set false as the cycle begins.
- The solenoids are energized and the Air Cylinder starts moving toward the parts.
- If the trigger mode is set for "Distance", Sonics will start when the trigger distance is reached or from the Home position if the trigger distance value is 0.000.
- The Pressure switch closes when the head contacts the parts. If Sonics is ON already the WELD TIME begins immediately.
- If Sonics is NOT running at contact, the pressure switch is de-bounced or the delay time begins or the system waits for a Force Trigger.
- When the PSW debounce is stable or the delay time is complete or the proper Force is achieved, the WELD TIME begins.
- While the system is welding, it will monitor the Time, Distance and Energy setpoints. When the first setpoint value is reached, SONICS will be turned OFF.
- End of Welding: The vibration has stopped because the system has reached one of the setpoints or an external sonic stop signal has terminated the weld so the system starts the Hold time to allow the weld joint to cure.
- When the Hold time is complete, the repulse time begins as the head begins to retract from the welded parts. Sonics will be turned ON for the repulse time length to prevent the parts from sticking to the horn.
- The weld data is captured for examination against the limit windows settings and the Good Part/ Bad Part outputs are set.
- The print line containing the last weld information is sent if it is turned ON (micro board switch 5).
- If the impulse and both palm button signals have been released, the display info is updated with the last weld numbers for time, distance and energy. If the weld terminated by one of the setpoints, the appropriate data label will be blinking as an indication.
- The ready signal returns to true indicating that the cycle has completed and the system is ready for the next weld cycle.

End of Weld Cycle

53 CHURCH HILL RD.  
NEWTOWN, CT 06470

**SONICS**



**Basic Weld Cycle Time Line**

DRAWN BY	WPS	SCALE	DRAWING NO.
CHKD		DATE	E-3177
MATERIAL			

**TOLERANCES**  
(EXCEPT AS NOTED)

DECIMAL	
X=+/-0.030	
XX=+/-0.015	
XXX=+/-0.005	
FRACTIONAL	
+/- 1/64	
ANGULAR	
+/- 1/2 DEG.	

**Basic Time Line**

CONFIDENTIAL INFORMATION  
THE INFORMATION AND DATA CONTAINED HEREIN IS PROPRIETARY AND IS SUBMITTED IN CONFIDENCE AND SHALL NOT BE DISCLOSED, USED OR DUPLICATED FOR ANY PURPOSE WHATSOEVER WITHOUT THE PRIOR WRITTEN PERMISSION OF SONICS & MATERIALS INC., NEWTOWN, CT. THIS LEGEND SHALL BE MARKED ON ANY REPRODUCTIONS HEREOF IN WHOLE OR IN PART. RECEIPT OF THIS DOCUMENT SHALL BE DEEMED TO BE AN ACCEPTANCE OF THE CONDITIONS SPECIFIED HEREIN.

## G-SERIES SWITCHES

SWITCH	POS. OFF	POS. ON	DEFAULT
SW2-1	Program Flash (Production only)	Enable-WD (Always on)	ON
SW2-2	Cylinder Pot (Future option)	Optical Encoder	ON
SW2-3	Auto Start	Wait for 'ENTER'	ON
SW2-4	English	Metric	OFF
SW2-5	Print Line-OFF	Print Line-ON	OFF
SW2-6	Reserved For Future Expansion		
SW2-7	TXT Print Line	Future Option	OFF
SW2-8	Reserved For Future Expansion		